



Part of Energy Queensland



STNW3522

# Standard for Major Customer Connections

Effective from 25 October 2022

## Table of Contents

<b>1</b>	<b>Introduction .....</b>	<b>2</b>
1.1	Purpose.....	2
1.2	Scope.....	2
1.3	Obligation of Major Customers .....	2
1.4	Summary of the Connection process.....	3
<b>2</b>	<b>Definitions and abbreviations.....</b>	<b>3</b>
2.1	Definitions .....	3
2.2	Abbreviations .....	6
2.3	Terminology .....	7
<b>3</b>	<b>Relevant rules, regulations, standards and codes.....</b>	<b>7</b>
3.1	Energex and Ergon Energy controlled documents.....	8
3.2	Australian and New Zealand Standards .....	8
3.3	International Standards .....	9
3.4	Legislation, regulation and references .....	9
<b>4</b>	<b>Technical requirements .....</b>	<b>10</b>
4.1	General Requirements .....	10
4.2	Shared Assets.....	10
4.3	Labelling and signage .....	10
4.4	Maximum system capacity .....	11
4.5	Connection control .....	11
4.6	Network Connection and isolation .....	12
4.7	Earthing.....	13
4.8	Plant approval and compliance.....	14
4.9	Operating voltage and frequency settings .....	15
4.10	Protection.....	15
4.11	Metering .....	16
4.12	Power quality.....	17
4.13	Communications and SCADA requirements .....	20
4.14	Data and information .....	21
4.15	Cybersecurity .....	22
4.16	Technical Studies .....	24

# Standard for Major Customer Connections



4.17	Interlocking .....	25
4.18	Load Shedding Schemes .....	26
<b>5</b>	<b>Testing and commissioning .....</b>	<b>27</b>
<b>6</b>	<b>Operations and maintenance.....</b>	<b>27</b>
6.1	General .....	27
6.2	HV Connections .....	28
6.3	Operating protocol.....	29
<b>Appendix A – Major Connection Arrangement Options (normative).....</b>		<b>30</b>
Low Voltage Connections .....		31
L.1	Standard LV Connections - overhead .....	31
L.2	Standard LV Connections - underground.....	32
L.3	Overhead LV Connection with dual transformer supply .....	33
L.4	LV Connection with dual transformer supply (separate HV overhead feeders).....	34
L.5	Underground LV Connection with dual transformer supply .....	35
L.6	LV Connection via chamber substation.....	37
L.7	LV mesh Connection .....	38
High Voltage Connections .....		39
H.1	11 / 22 kV / 33kV (Distribution) simple overhead Connection .....	39
H.2	11 / 22 kV / 33kV (Distribution) Simple underground Connection .....	40
H.3	11 / 22 kV / 33 kV (Distribution) dedicated Connection.....	41
H.4	11 / 22 kV / 33 kV (Distribution)– dual supply .....	42
H.5	11kV – mesh connection .....	43
Sub-Transmission Network Connections .....		44
S.1	Sub-Transmission - “T” Connection.....	44
S.2	Sub-transmission - dedicated Connection .....	45
S.3	Sub-Transmission Connection via switching station .....	46
S.4	Sub-Transmission Connection – three bay tee .....	47
S.5	Sub-Transmission Connection via dual feeders – Option 1 .....	48
S.6	Sub-Transmission Connection via dual feeders – Option 2 .....	49
<b>Appendix B: Protection and communications design requirements (normative) .....</b>		<b>50</b>
B.1	General .....	50
Protection Scheme Arrangements .....		50
B.2	Distribution .....	50

# Standard for Major Customer Connections



---

B.3 Transmission / Sub-transmission.....	51
B.4 Switching stations.....	52
<b>Appendix C: Data and Information (informative) .....</b>	<b>54</b>
C.1 Format for designs .....	54
C.2 Use of AutoCAD and relevant numbering requirements .....	54
<b>Appendix D: Works classification and construction options (normative) .....</b>	<b>55</b>
D.1 Construction and ownership options .....	55
D.2 Works classification and construction options .....	56
<b>Appendix E: Scada and Communications Requirements (informative) .....</b>	<b>59</b>
E.1 Time stamp data and sequence of events .....	59
E.2 DNSP control systems hardware .....	59
E.3 Minimum customer SCADA Requirement.....	59
E.4 Other SCADA protocols.....	59
E.5 Communications Link .....	59
E.6 SCADA Protocol & Configuration .....	60
E.7 DNP3 Object types .....	61
E.8 Analog resolution.....	62

## 1 Introduction

### 1.1 Purpose

The purpose of this Standard is to specify the technical requirements that Major Customers must comply with in order to establish a new Connection, or to alter an existing Connection, with the Energex or Ergon Energy Distribution Network.

### 1.2 Scope

This Standard is intended for use by parties that are designated by the DNSP in its Annual Pricing Proposal as “Major Customers”. Major Customer Connections are those that fall within the tariff classes of Connection Asset Customer (CAC), Individually Calculated Customer (ICC), or embedded generators or real estate developments. Major Customer Connections to which this standard applies include:

- a. large commercial Premises coupled at high voltage with an installed capacity of greater than 1,000 kVA (1 MVA); and / or
- b. Micro-Embedded generating units with an installed capacity of greater than 30 kVA; and / or
- c. Non-Registered Embedded Generators i.e. with an installed capacity of greater than 200 kVA; and / or
- d. large *load* premises coupled at low voltage with an installed capacity of greater than 1,000 kVA (1 MVA) and/or
- e. real estate developments, which include the commercial development of land in one or more of the following ways:
  - i. residential housing and commercial and / or industrial subdivisions; and / or
  - ii. commercial and / or industrial multi-tenanted Premises, e.g. shopping centres and office buildings; and / or
  - iii. multi-residential Premises, e.g. residential unit towers<sup>1</sup>.

This Standard may also apply to Embedded Networks, where these include generation or *loads* described in a-e above. For Embedded Networks, requirements shall apply at the Connection Point of the Embedded Network.

### 1.3 Obligation of Major Customers

Major Customers must comply with the applicable Connection process (and associated requirements) and the terms and conditions of their agreement(s) with the DNSP, before establishing or altering a Connection. Further information is available in the Major Customer Connection Manual (referred to as “the Manual” in this Standard). It is not intended to be applied retroactively to existing Connections where there have been no alterations.

---

<sup>1</sup> A real estate development involves the development of “land itself” for commercial gain. That is, where once developed, the land and any improvements thereon will generally be sold for commercial gain, e.g. a residential unit tower. This is to be distinguished from the development or construction of commercial or industrial premises on land, where that premises will be used for ongoing commercial or industrial purposes, e.g. a factory or mine site.

## 1.4 Summary of the Connection process

A description of the Major Customer Connection process along with the applicable regulatory framework is set out in the Manual, as well as the Major Customer sections of the Ergon Energy Network and Energex websites:

- Ergon Energy Network - <https://www.ergon.com.au/network/connections/major-business-connections/major-connections>)
- Energex - <https://www.energex.com.au/home/our-services/connections/major-business/large-customer-connections>)

## 2 Definitions and abbreviations

### 2.1 Definitions<sup>2</sup>

Term	Definition
Accredited Auditor	Has the meaning given to that term in the <i>Electrical Safety Act 2002</i> (Qld)
Alternative Control Services (ACS)	A distribution service provided by the DNSP that the AER has classified as an alternative control service under the NER. In this Standard, a reference to a service classified as ACS will be to those elements of the Connection Assets that are typically only utilised by, or for the benefit of, the Major Customer. Refer to Enhanced connection services for augmentation of the shared network.
Connection	A physical link between the Distribution System and the Premises of a Major Customer to allow the flow of electricity across the Connection Point.
Connection Agreement	Depending on the context, refers to a contract between the DNSP and the Major Customer in respect of either or both of the following: <ul style="list-style-type: none"> <li>• agreement to carry out certain works to either establish or alter a Connection (typically, this may be a NCEC);</li> <li>• agreement for the provision of Ongoing Services (typically, this may be a NOCC).</li> </ul>
Connection Applicant	A Major Customer that has, or intends to, submit a Connection Application. For the avoidance of doubt, where another party submits a Connection Application on behalf of the Major Customer (for example, as described in the relevant definition in rule 5A.A.1 of the NER or a contractor or consultant engaged by the Major Customer) the Connection Applicant is the Major Customer, not the party submitting the Application.
Connection Application	An application to connect, or alter the Connection of, a Major Customer's Premises to the Distribution Network.

<sup>2</sup> Terms in italics and not otherwise defined in this document, have the meaning given to that term in the NER or National Energy Retail Law.

# Standard for Major Customer Connections



Part of Energy Queensland

Term	Definition
Connection Assets	<p>Those components of a Distribution System which are used to provide <i>connection services</i>.</p> <p>Connection Assets are all components used to connect a particular customer's electrical installation to the shared Distribution Network, which are not used by other customers (including a dedicated extension). The Connection Assets required to connect a Major Customer to the Distribution Network can include:</p> <ul style="list-style-type: none"> <li>• High voltage overhead or underground mains</li> <li>• Low voltage overhead or underground mains and services</li> <li>• Distribution transformers, and</li> <li>• Protection Systems.</li> </ul>
Connection Point	<p>The physical point or link where the DNSP's assets meet the Major Customer's assets so as to permit the flow of electricity between the assets, being the agreed point of supply.</p>
Distribution Network	<p>A <i>network</i> owned and operated by a Distribution Network Service Provider that is not a transmission network (i.e. a network that is owned by a Transmission Network Service Provider).</p>
Distribution System	<p>The relevant Distribution Network, together with the Connection Assets associated with that Distribution Network to which the Major Customer is, or will be, connected.</p>
Distribution Network Service Provider or DNSP	<p>Depending on the context means either Energex (who owns and operates the Distribution System in South East Queensland) or Ergon Energy (who owns and operates the Distribution System in the remainder of Queensland).</p>
Dynamic Connection Standards	<p>Standards created that achieves the functional requirements as described in Section 4.5.1 of this Standard. STNW3511 is currently published that fits in that scope.</p>
EG Standard(s)	<p>DNSP Standards relating to EG Systems. Currently it has STNW1174, STNW1175, STNW3511 that may be applicable for a Major Customer.</p>
Embedded Generating System(s) (or EG System(s))	<p>One or more Embedded Generating Units and auxiliary equipment that are interconnected with a Distribution Network.</p>
Embedded Generating Unit	<p>A Generating Unit connected within a Distribution Network and not having direct access to the transmission network.</p>
Embedded Generator	<p>Broadly, an entity who is registered with AEMO in respect of the ownership, operation or control of an Embedded Generating System.</p>
Embedded Network	<p>A distribution system, connected at a parent connection point to either a distribution system that forms part of the national grid, and which is owned, controlled or operated by a person who is not a Network Service Provider.</p>
Energy Laws	<p>Has the meaning given to that term in the NERL, which, for the avoidance of doubt, includes the Electricity Distribution Network Code under the <i>Electricity Act 1994</i> (Qld).</p> <p>Relevant laws relating to the subject matter of this Standard at the date of publication of this Standard are set out in Section 3.4 (NB this list may not be exhaustive or complete).</p>
Energy and Safety Laws	<p>Means:</p> <ol style="list-style-type: none"> <li>a. the Energy Laws;</li> <li>b. the Safety Laws; and</li> <li>c. any other relevant rules, regulations, instruments and plans;</li> </ol>

STNW3522

Document ID: 9148501

Release 2, 24/12/2024

# Standard for Major Customer Connections



Part of Energy Queensland

Term	Definition
Energy Storage System (or ESS)	A system comprising one or more components (e.g batteries) that store electricity generated by Distributed Energy Resources or directly from the grid, and that can discharge the electricity to <i>loads</i> .
Enhanced connection services	Categorised as ACS, connection services provided at the request of a customer or third party include those that are: <ul style="list-style-type: none"> <li>• provided with higher quality of reliability standards, or lower quality of reliability standards (where permissible) than required by the NER or any other applicable regulatory instruments</li> <li>• in excess of levels of service or plant ratings required to be provided by the distributor, and</li> <li>• for embedded generators, including the removal of network constraints.</li> </ul>
Generating Unit	The plant used in the production of electricity and all related equipment essential to its functioning as a single entity.
Generation	The production of electrical power by converting another form of energy in a Generating Unit.
High Voltage (or HV)	Any voltage greater than 1 kV a.c.
Inverter Energy System (or IES)	A system comprising one or more inverters together with one or more energy sources (which may include batteries for energy storage) and controls.
Low Voltage (or LV)	A voltage of no more than 1,000 V a.c. or 1,500 V d.c.
Major Customer	Refers to an entity or person that comes within the scope described in Section 1.2 of this Standard.
Manual	Refers to the Major Customer Connection Manual published by the DNSP and available at <a href="http://www.energex.com.au">www.energex.com.au</a> or <a href="http://www.ergon.com.au">www.ergon.com.au</a>
National Electricity Law (or NEL)	The <i>NEL</i> as it applies in Queensland under the National Electricity (Queensland) Law, as defined in the <i>Electricity - National Scheme (Queensland) Act 1997</i> (Qld), and under which the NER are established.
National Electricity Market (or NEM)	The name of the wholesale electricity market in Australia and the associated interconnected <i>national grid</i> .
National Electricity Rules (or NER)	The NER are made under the NEL. The NER governs the operation of the NEM.
National Energy Retail Law (or NERL)	The National Energy Retail Law (Queensland), as defined in the <i>National Energy Retail Law (Queensland) Act 2014</i> (Qld).
Network	The apparatus, equipment, plant and buildings used to convey, and control the conveyance of, electricity excluding any Connection Assets. In relation to a Network Service Provider, a network owned, operated or controlled by that Network Service Provider.
Network Coupling Point	The point at which Connection Assets join the shared Distribution Network, used to identify the distribution service price payable by the Major Customer. The Network Coupling Point marks the boundary between the dedicated Connection Assets and the shared Distribution Network.
Non-Registered Embedded Generator	An embedded generator that is neither a micro-embedded generator nor a Registered Participant.
Ongoing Services	Refers to the provision of ongoing connection services by the DNSP to the relevant Major Customer at the Connection Point. For the avoidance of doubt, this may cover <i>customer connection services</i> , <i>connection services</i> or <i>network services</i> .



# Standard for Major Customer Connections

Term	Definition
Premises	Means any land (whether a single block or multiple contiguous blocks), building(s) (whether whole or part), and structure(s) (or adjuncts thereto) that are owned, occupied or controlled by the Major Customer in the vicinity of the proposed Connection, and which can reasonably be considered to be part of a single overarching operation.
Protection Scheme	A grouping of primary and secondary plant intended to detect and clear all credible fault scenarios from a section of an electrical network. A scheme can include (but is not limited to) protection relays, communications systems, interposing relays, instrument transformers and circuit breakers.
Protection System	A number of protection schemes intended to detect and clear all credible fault scenarios from a Network, that meet the requirements of the Energy Laws and meet operational requirements.
Registered Participant	A person who is registered by AEMO in any one or more of the categories listed in rules 2.2 to 2.7 of the NER.
Service Provider	A person or organisation on the Approved Contractors' Register approved by the DNSP to carry out design and/or construction of certain electrical works for assets on the basis of experience and meeting registration and certification requirements.
Shared Network Assets	All the assets on the Distribution Network side of the Network Coupling Point, for the conveyance of electricity to more than one Distribution Network User.
Standard	This document entitled "Major Customer Connection Standard".
Standard Control Services (SCS)	A distribution service provided by the DNSP that the AER has classified as a standard control service. In this Standard, SCS generally covers services and element within the Connection Assets that can be utilised by or benefit other Distribution Network users.
Sub-transmission	DNSP's Network for the purpose of carrying electricity from bulk supply substations to zone substations. Normally includes 132kV, 110kV, 66kV feeders and many 33kV feeders in Queensland.
Technical Study	A study to evaluate the effects that the proposed Connection will have on the Distribution System.
Transferable Connection Assets	Refers to assets constructed by or on behalf of a Major Customer in respect of a Major Customer Connection where, under the terms of the NCEC, the ownership of these assets is to be transferred to the DNSP upon completion (refer to Manual for further information on this arrangement).

## 2.2 Abbreviations

Term, abbreviation or acronym	Definition
AEMC	Australian Energy Market Commission
AEMO	Australian Energy Market Operator
AS/NZS	A jointly developed Australian and New Zealand Standard
AS	Australian Standard
BOO	Build, Own and Operate
CAD	Computer Aided Design

# Standard for Major Customer Connections

Term, abbreviation or acronym	Definition
CBD	Central Business District
DCT	Design, Construct and Transfer
GDD	Grid Disconnection Device
GIS	Geographic Information System
GPR	Grid Protection Relay
IEC	International Electrotechnical Commission
IEEE	Institute of Electrical and Electronics Engineers
NCEC	Network Connection Establishment Contract
NOCC	Negotiated Ongoing Connection Contract
NER	National Electricity Rules
NVD	Neutral Voltage Displacement
OH	Overhead
PQ	Power Quality
RPEQ	Registered Professional Engineer of Queensland
STATCOM	Static synchronous compensator
UG	Underground

## 2.3 Terminology

In this Standard:

- the word “shall” indicates a mandatory requirement the Major Customer must comply with; and
- the word “should” indicates a recommended requirement that will not be mandatorily imposed on the Major Customer; and
- the word “may” indicates a requirement the DNSP may determine the Major Customer must comply with.

## 3 Relevant rules, regulations, standards and codes

There are a range of applicable standards and industry codes which define Connection types and requirements, and network standards as set out below.

In the event of any inconsistency between:

- Australian and international standards and industry codes (except for legislated industry codes); and
- this Standard,

this Standard will prevail.

# Standard for Major Customer Connections

## 3.1 Energex and Ergon Energy controlled documents

A copy of the latest version of this Standard may be obtained by searching for Major Customer Connections from the following websites:

<https://www.energex.com.au/>

<https://www.ergon.com.au/>

Other controlled documents relevant to this Standard include:

Document number	Document name	Document type
01811	Queensland Electricity Connection Manual	Reference
<b>00768</b>	Major Customer Connection Manual	Reference
STNW1174	Standard for Low Voltage Embedded Generating Connections	Standard
STNW1175	Standard for High Voltage Embedded Generating Connections	Standard
STNW1179	Standard for Plant Energisation	Standard
STNW3039	Network Physical Security – Design Reference	Standard
STNW3511	Dynamic Standard for Low Voltage Embedded Generation Connections	Standard

## 3.2 Australian and New Zealand Standards

Document number	Document name	Document type
AS 2067	Substations and high voltage installations exceeding 1 kV a.c.	Australian Standard
AS/NZS 3000	Electrical installations (known as the Australian/New Zealand Wiring Rules)	AU/NZ Joint Standard
AS/NZS 3835.1	Earth potential rise – Protection of telecommunications network users, personnel and plant (Part 1: Code of Practice)	AU/NZ Joint Standard
AS/NZS 3835.2	Earth potential rise – Protection of telecommunications network users, personnel and plant (Part 2: Application Guide)	AU/NZ Joint Standard
AS/NZS 4777.1	Grid Connection of energy systems via inverters (Part 1: Installation Requirements)	AU/NZ Joint Standard
AS/NZS 4777.2	Grid Connection of energy systems via inverters (Part 2: Inverter Requirements)	AU/NZ Joint Standard
AS/NZS 4853	Electrical hazards on metallic pipelines	AU/NZ Joint Standard
AS 7000	Overhead line design standard	Australian Standard
AS 60038	Standard Voltages	Australian Standard
AS/NZS 61000 Series	Electromagnetic compatibility	AU/NZ Joint Standard

# Standard for Major Customer Connections

## 3.3 International Standards

Document number	Document name	Document type
IEEE Std 519 – 2014	IEEE Recommended Practices and Requirements for Harmonic Control in Electrical Power Systems	International Standard

## 3.4 Legislation, regulation and references

Set out below is a list of the relevant legislation, regulations and references.

In the event of any inconsistency between:

- legislation and regulation; and
- this Standard,

the legislation and regulations shall prevail.

Document name	Document type
Construction and operation of solar farms – Code of Practice 2019	Code of Practice
Electricity Act 1994 (Qld)	Legislation
Electricity Regulation 2006 (Qld)	Regulation
Electrical Safety Act 2002 (Qld)	Legislation
Electrical Safety Regulation 2013 (Qld)	Regulation
Electricity – National Scheme (Queensland) Act 1997 (Qld)	Legislation
National Electricity (Queensland) Law, as defined in the Electricity – National Scheme (Queensland) Act 1997 (Qld)	Legislation
National Energy Retail Law (Queensland) Act 2014 (Qld)	Legislation
National Energy Retail Law (Queensland), as defined in the National Energy Retail Law (Queensland) Act 2014 (Qld)	Legislation
National Electricity Law	Legislation
National Electricity Rules	Regulation
Professional Engineers Act 2002 (Qld)	Legislation
Distribution Determination Ergon Energy 2020-2025, 5 June 2020	Reference
Distribution Determination Energex 2020-2025, 5 June 2020	Reference
Ergon Energy Connection Policy	Reference
Energex Connection Policy	Reference
Ergon Energy Tariff Structure Statement	Reference
Energex Tariff Structure Statement	Reference

## 4 Technical requirements

### 4.1 General Requirements

This Standard applies to Connections that come within the scope defined in Section 1.2. The technical requirements set out in this standard are applicable for all new Major Customer connections. Existing Major Customers proposing to undertake a change to their connection, for example but not limited to, additional demand that necessitates augmentation, addition of generation, or changes to the performance of the Premises require a review of existing arrangements to align to this Standard.

Major Customer EG Systems shall also be subject to the applicable DNSP's EG Standards as follows:

- a. STNW1174 – For EG Systems connected at low voltage as fixed EG System Connections
- b. STNW3511 – For EG Systems connected at low voltage as dynamic Connections
- c. STNW1175 – For EG Systems connected at high voltage

Generally, EG Systems will be subject to additional conditions that are captured separately in the EG standards above. This Standard, where it refers to EG Systems as a Major Customer, shall refer back to the relevant EG Standard. Where it is unspecified for any category within this Standard, it shall be assumed that the requirements are common for all Major Customers.

### 4.2 Shared Assets

There shall be no shared primary plant assets and auxiliary supplies at the Major Customer side of the Connection Point. The exceptions allowed are:

- a. where a voltage transformer (VT) or current transformer (CT) secondary winding / circuit can be dedicated to the DNSP from a Major Customer's asset. The DC and LV AC supply can be provided by the Major Customer to the DNSP for Power Quality Analyzer installation.
- b. one Major Customer owned LV AC supply to be shared with the DNSP as backup to the DNSP LV AC supply where it is required to ensure reliable charging to DC supply of the DNSP auxiliary systems of the Connection Assets.
- c. In some cases, circuit breaker functions may be shared via protection signalling.

### 4.3 Labelling and signage

All installations shall comply with AS 2067 and AS/NZS 3000.

The DNSP shall provide the Major Customer with details of the operational and identification labels that the Major Customer shall place on items of equipment, substation buildings and enclosures comprising the Transferable Connection Assets (DCT) and other assets that are required for isolating access to the Distribution System. The unique ID of switching plant at the Connection Point shall not be changed without consultation with the DNSP. The Major Customer shall give the DNSP a list identifying each item of equipment with label identification, make, model and serial number.

## 4.4 Maximum system capacity

### 4.4.1 Aggregate capacity considerations

The maximum capacity for any Connection Point in respect of a Premises is based on the aggregate of all the maximum demand or connected capacity of the EG Systems authorised to be connected within that Premises.

For Premises with multiple Connection Points, or EG System(s) within a Premises being connected to multiple Connection Points:

- a. The maximum capacity for any Connection Point in respect of a Premises is based on the aggregate of all the maximum demand or connected capacity of the EG Systems authorised to be connected within that Premises.
- b. The requirements set out in this Standard and any Technical Study will be applied and determined based on the aggregate maximum capacity of all the EG Units connected and the maximum aggregate demand, or proposed aggregate to be connected, within the Premises.

This aggregate capacity consideration is irrespective of any interlocking or electrical separation of the multiple supplies at the Premises.

## 4.5 Connection control

Major Customer Premises with *loads* and EG Systems should have a central control mechanism to ensure DNSP performance requirements are met at the Connection Point. A central control scheme shall influence and preferably coordinate all *loads* and EG Systems within the Connection Point. The central control scheme shall be separate to a Protection Scheme at the Major Customer's Premises and ensures the performance at the Connection Point complies with the Connection Agreement. Central control schemes can include (but not limited to):

- a. Plant overload or runback scheme.
- b. Anti-islanding scheme.

The Technical Study shall determine the suitability of the central control scheme as required per Table 1.

**Table 1 Central control scheme requirements**

Connection Category	Central Control Scheme Requirement <sup>1</sup>
EG System capacity > 1.5 MVA	Shall be required
<i>Load</i> , authorised demand > 3 MVA	May be required at DNSP discretion according to Distribution Network conditions, including connections on the sub-transmission Network and weak Network areas
All other existing Major Customer <i>load</i> Connections when adding EG Systems	Required as per EG System or <i>load</i> requirement above

Note 1: The control scheme may comprise a dynamic Connection as defined in 4.5.1.

### 4.5.1 Dynamic Connections

The DNSP has enabled dynamic Connection capability for LV Connections. This offers Connections a real time, variable active power import / export limit from the DNSP with capacity limits forecasted ahead. Refer to the relevant Dynamic Connection Standard for further requirements.

## 4.6 Network Connection and isolation

The DNSP and the Major Customer shall have an isolation device that can isolate the Connection Point. An isolation device is not used to interrupt faults; rather it is used to physically isolate and disconnect the Major Customer's installation from the Distribution System to facilitate access to perform work on the Distribution System.

The location of the isolation device shall be as close as possible to the Connection Point. The isolation device shall be owned by the DNSP, except for dedicated underground HV distribution feeder Connections. Appendix A details connection arrangements that are permitted for Major Customers.

Where technically feasible, consideration may be given to allowing momentary paralleling of the DNSP's high voltage feeders, to permit transfer from one feeder to the other without interruption to supply. If feasible and approved, this must be documented in an operating protocol that is part of the Connection Agreement.

Permanent paralleling of high voltage feeders to provide a no-break supply may also be considered at the Technical Study, subject to the installation of additional protection at the zone substation and the Major Customer's installation at the Major Customer's expense.

### 4.6.1 Grid Disconnection Device (GDD)

To enable rapid disconnection and minimise Distribution System impact at the Connection Point, a Grid Disconnection Device (GDD) shall be installed at or near the Connection Point.

A GDD shall consist of a HV Automatic Circuit Recloser (ACR) or a HV circuit breaker within a switchboard.

The GDD shall be supported by a Protection Scheme covering the requirement of a disconnection device redundancy in Section 4.10.1.

In the instance of a Major Customer owned HV circuit breaker as the GDD, a DNSP owned Protection Scheme with remote communication shall be installed at the Major Customer's expense to enable DNSP visibility and disconnection over the GDD.

Where a DNSP owned GDD is required for LV Connection Points, this would be installed at or on the Distribution Network side of the HV Network Coupling Point.

Where a GDD is not required for a new Major Customer Connection (e.g. on LV load Connections), the Major Customer should consider allowing provision for *plant* space for a GDD enablement in a future scenario of a Connection alteration (i.e. future EG additions).

GDD requirements for various Major Customer Connection arrangements are covered in Table 2.

Table 2 GDD requirements and ownership

Supply voltages / Network type	Shared Network / Dedicated	Connection category	GDD required	GDD ownership	Secondary system ownership
LV	Shared	Load &/or EG System $\leq$ 1.5 MVA	No	n/a	n/a
		EG System $>$ 1.5 MVA	Yes	DNSP	DNSP
11-33 kV Distribution Network	Dedicated	Load &/or EG System $\leq$ 1.5 MVA	No	n/a	n/a
	Shared	Load &/or EG System $\leq$ 1.5 MVA	May be required <sup>1</sup>	DNSP	DNSP
	Dedicated	EG System $>$ 1.5 MVA	Yes	Customer <sup>1,2</sup>	DNSP
	Shared	EG System $>$ 1.5 MVA	Yes	DNSP	DNSP
Sub-transmission	Dedicated radial	Load / EG System	Yes	Customer <sup>1</sup>	DNSP
	All other Connection arrangements	Load / EG System	Yes	DNSP	DNSP

Note 1 : A DNSP owned GDD shall be required at the Connection Point unless Major Customer can demonstrate N-1 protection redundancy capability for a Connection Point disconnection as per Section 4.10.1.

Note 2: Refer Appendix A for further details on requirements

## 4.6.2 HV Isolation and access requirements

The following shall be provided for safe operation of the Major Customer's HV installation and the Distribution System:

- The incoming high voltage cable shall be capable of being earthed via a fault make rated earth switch, located on the Network side of the Main Switch or Circuit Breaker as relevant; and
- The earth switch shall be integral to the high voltage metering transformers and Main Circuit Breaker switchgear assembly; and
- The earth switch shall be capable of having a DNSP lock in the "OFF" and "EARTHED" positions; and
- When more than one high voltage supply is provided to a Major Customer, the supplies may require interlocking in such a manner that paralleling of the High Voltage supplies could not be possible, unless arrangements have been made to provide a permanent parallel configuration.

## 4.7 Earthing

Earthing designs shall comply with the requirements set out in AS/NZS 7000, AS 2067 and AS/NZS 3000 as relevant. Earthing designs may also need to comply with other relevant standards including AS/NZS 3835.1, AS/NZS 3835.2 and AS/NZS 4853.



The applicable requirements in respect of the earthing of the Major Customer’s HV installation and the earthing of the Distribution System must be documented in the Connection Agreement, including whether these must be separated (i.e. isolated) from one another or can be interconnected together (i.e. bonded). Consideration should be made for bonding the Major Customer’s HV installation and the Distribution System where secondary systems cross ownership boundaries, or where the two earthing systems cannot be effectively isolated from one another.

## 4.8 Plant approval and compliance

This section sets out *plant* approval and compliance requirements for all Major Customer Connections.

### 4.8.1 Fault level of *plant*

The Major Customer shall be responsible for ensuring the fault level withstand capability of their *plant* is sufficient and maintained. It is recommended to specify *plant* to equal or greater fault withstand than the fault ratings in Table 3 at the Connection Point and an appropriate scaled level within the Premises, depending on impedances and applicable fault current sources. In the context of Table 3, Primary plant is *plant* that is directly associated with a bulk supply or zone substation of DNSP whilst secondary plant is *plant* on the Distribution System downstream of a bulk supply or zone substation circuit breaker. In some circumstances, higher withstand will be required, which will be advised with the Technical Study (see Section 4.16).

**Table 3 Fault withstand capability levels for equipment related to system voltage**

Voltage	Primary plant	Secondary plant
132/110 kV	40 kA / 1 s	40 kA / 1 s
66 kV	25 kA / 3 s	25 kA / 3 s
33 kV	31.5 kA / 3 s	25 kA / 3 s
22 kV	25 kA / 3 s	20 kA / 3 s
11 kV	25 kA / 3 s	20 kA / 3 s

### 4.8.2 Protection equipment

Protection equipment, both utilised by the DNSP and Grid Protection Relays (GPR) utilised by the Major Customer shall operate the relevant disconnection device either directly or through interposing equipment. Such protection equipment and any interposing equipment shall have certified compliance with the following:

- a. IEC 60255-1 Common requirements
- b. IEC 60255-26 EMC requirements
- c. IEC 60255-27 Product safety requirements
- d. IEC 60255-127 Functional requirements for over/under voltage protection, and
- e. IEC 60255-181 Functional requirements for frequency protection.

Marshalling of protection trips through control equipment shall be compliant with IEC 60255.

The instrument transformers used to interface the protection equipment with the Major Customer's installation shall have certified compliance with:

- i. AS 61869-1 General requirements
- ii. AS 61869-2 Additional requirements for current transformers
- iii. AS 61869-3 Additional requirements for inductive voltage transformers, and
- iv. AS 61869-4 Additional requirements for combined transformers.

## 4.9 Operating voltage and frequency settings

The Major Customer shall implement and maintain the operating voltage and frequency settings that are set out in the Connection Agreement, which must not be altered without the written agreement of the DNSP.

## 4.10 Protection

The design and operation of the Protection Systems associated with a connection of a Major Customer shall be in accordance with the NER, other relevant Energy and Safety Laws and the operational and planning requirements of the DNSP.

The Major Customer shall provide the following to the DNSP (endorsed by an RPEQ):

- a. Satisfactory demonstration that the elements of the Major Customer's Protection System coordinate adequately with the DNSP's Protection Systems over the range of credible fault levels common to both the Major Customer's and the DNSP's Protection Systems. Coordination is required at all related protection thresholds including (but not limited to) time and current and/or impedance and/or voltage, etc. The coordination margins shall be determined by the DNSP.
- b. Confirmation the Major Customer's Protection System design is compliant with the requirements of the NER, other relevant Energy and Safety Laws and the operational and planning requirements of the DNSP, including (but not limited to):
  - i. Detect and clears all credible fault scenarios within the Major Customer's facility.
  - ii. Having clearing times as required by the NER and/or the DNSP.
  - iii. Having an N-1 Protection System, meaning that there is sufficient redundancy such that with any one element causing a Protection Scheme to be out of service, then another Protection Scheme will remain in service. Note the elements of a Protection Scheme can include protection relays and related DC systems, communication equipment and related DC systems, circuit breakers, instrument transformers, etc.

## 4.10.1 Major Customer backup protection

It is the expectation that a Major Customer has a Protection System that has N-1 Protection Schemes. Where the Major Customer's Protection System has only one Protection Scheme, they may request that the DNSP provides a backup Protection Scheme. The request shall need to be submitted during the Connection Application. Where an operationally practical solution can be provided by the DNSP, it will be offered and implemented by the DNSP at a cost to the Major Customer.

If the DNSP provides a backup Protection Scheme for a Major Customer, then this shall be documented in the Connection Agreement.

## 4.10.2 Shared Protection Systems

For standard Protection System arrangement options, refer to Appendix B.

Where Protection Systems span beyond the Connection Point, they are in effect a shared Protection System. These shared Protection Systems shall comply with the following principles.

- a. Where Protection Schemes include protection relays that are maintained and operated by the Major Customer, these relays shall comply with the DNSP's present protection relay period contracts. The relay period contract stipulates relay models, relay firmware versions and proprietary setting configuration software versions; and
- b. The Major Customer shall comply with the standard application guides created by the DNSP for each relay application. The DNSP's standard application guide covers standardised protection settings for a particular relay model with regards to the functions required in its application.

## 4.10.3 Communicating protection schemes

Communicating line protection schemes shall be limited to either two or three ends. Four ended schemes are not supported by the DNSP.

## 4.10.4 Inter-tripping

The Major Customer's Protection System design shall not be based solely on an inter-trip from the DNSP. Direct inter-tripping from or to the DNSP can be an ancillary part of a Protection System, such as a direct inter-trip resulting from a circuit breaker fail.

Inter-tripping as part of a control scheme is not considered part of a Protection Scheme.

## 4.11 Metering

The metering system design needs to be considered by the Major Customer as part of its planning phase with respect to the location of voltage and current transformers, metering panels and associated equipment, as well as ensuring compliance with the requirements set out in the NER, QECM and QEMM.

Approval to connect shall only be granted by the DNSP for compliant NER arrangements.

Regardless of ownership, the DNSP will require copies of the CT and VT test certificates prior to energisation. Where the measurement transformers are owned by the Major Customer, reports of recent maintenance history shall be made available if these assets provide secondary functions for the DNSP. Where the DNSP has agreed to allow the Major Customer access to metering cores on its CT and/or VT, the Major Customer must in return agree to cover the costs associated with the mandatory accuracy verification testing. Any change to the operation of these assets shall be reported to the DNSP.

## 4.12 Power quality

### 4.12.1 General

All power quality measurements, allocations and limits are with reference to the Connection Point.

All Major Customers shall comply with the performance standards set out in their Connection Agreement, Australian Standards and Energy and Safety Laws that are associated with power quality parameters. This may include, but not be limited to voltage fluctuation, voltage unbalance, harmonic emission limits or power factor requirements to assist the DNSP in maintaining Network capability, power system security, quality and reliability of supply.

Compliance with the power quality (PQ) limits as defined in the Connection Agreement shall be demonstrated in the following manner:

- a. For Embedded Generators, as part of the commissioning process as per rule 5.8 of the NER;
- b. For Non-Registered Embedded Generators, as part of the commissioning processes described in STNW1174 and STNW1175, as applicable;
- c. at DNSP discretion for Major Customers with disturbing *loads*, within three months of reaching full operational capability; and
- d. at DNSP discretion for all Major Customers if non-compliance is suspected.

Where requested, the Major Customer shall provide the DNSP with an RPEQ certified Power Quality Report presenting the power quality limits and the recorded results in accordance with the requirements set out in the Connection Agreement, in order to demonstrate compliance with the performance standards referred to in the Connection Agreement. The DNSP may at any time during the term of the Connection Agreement require the Major Customer to retest the performance requirements and provide evidence that the Major Customer is still compliant at the Connection Point.

Major Customers are required to monitor the Connection Point to maintain their continual compliance with the PQ limits set out in the Connection Agreement.

### 4.12.2 Voltage fluctuation and flicker

Voltage fluctuations are random or continuous variations of the Root-Mean-Square (RMS) voltage. Voltage fluctuations may be caused by rapid current changes by customer *load* switching and equipment starting, motor starts, arc furnaces, generators and welding equipment.

Flicker is the impression of fluctuating luminance resulting from voltage fluctuations on the supply systems defined in AS 61000 series as follows:

- Pst: the short-term flicker severity index where a value is obtained for each 10 minute period.
- Plt: the long-term flicker severity index where a value is obtained for each 2 hour period.

It is a requirement that the Major Customer maintains compliance with the emission limits as defined in the performance standards referred to in the Connection Agreement.

### 4.12.3 Harmonic distortion

Harmonic distortion of the voltage waveform is the result of non-linear currents caused by non-linear *loads* and Generating Systems connected to the Distribution Network. Common sources of harmonic distortion include switched mode power supplies, inverter-based technologies, arc furnaces and motors with variable speed drives or variable frequency drives.

Harmonic emission limits will be determined in accordance with Table 2 of IEEE 519 for Major Customers up to and including 1.5 MVA connected at LV, and in accordance with AS/NZS 61000.3.6:2001 for all other Major Customer Connections.

In the event a Major Customer needs to install a harmonic filter to reduce harmonics to meet the allocated harmonic emission limits, filter costs, construction footprints and delivery timescales can be significant. Therefore, it is important that developers and consultants are aware of the harmonic emission compliance as required by relevant Australian Standards and the NER during the planning for the project. The Major Customer should become familiar with the assessment process, technical specification, possible interactions with the DNSP's Audio Frequency Load Control (AFLC) and any review of the filter design.

#### 4.12.4 Harmonic Modelling requirements

Harmonic modelling is required for EG Systems 5 MVA and over to demonstrate compliance with the harmonic allocation prior to agreement of performance standards. EG Systems 1.5 - 5 MVA should perform harmonic modelling to ensure compliance prior to energising the Connection Point to avoid additional mitigation measures post-connection.

A harmonic model may be required for *loads* with distorting equipment greater than 5 MVA.

#### 4.12.5 Voltage unbalance

The Major Customer shall ensure that the Connection Point voltage is balanced to achieve an average voltage unbalance less than or equal to the values set in Table 4.

**Table 4 Voltage unbalance limits**

Nominal supply voltage (kV)	Maximum negative sequence voltage (% of nominal voltage)			
	No contingency event	Credible contingency event or protected event	General	Once per hour
	30 minute average	30 minute average	10 minute average	1 minute average
More than 100	0.5	0.7	1.0	2.0
More than 10 but not more than 100	1.3	1.3	2.0	2.5
10 or less	2.0	2.0	2.5	3.0

#### 4.12.6 Power factor

The permissible power factor range at the Connection Point for when the Premises is taking electricity from the Distribution System at the Connection Point, such that the *load* is equal to or greater than 30% of the authorised demand for importing electricity from the Distribution Network shall be in accordance with

# Standard for Major Customer Connections



Table 5. This is consistent with the automatic access standard set out in Table S5.3.1 of the NER and the requirements in the Electricity Regulations 2006 (Qld).

# Standard for Major Customer Connections



Part of Energy Queensland

Table 5 Power factor for *load*-only applications

Supply voltage (nominal)	Power factor range
< 1 kV	0.8 lagging to unity
1 kV < 50 kV	0.90 lagging to 0.9 leading
> 50 kV	0.95 lagging to unity

When the Premises are taking electricity from the Distribution Network at the Connection Point such that the *load* is less than 30% of the authorised demand for importing electricity, the DNSP at its discretion may accept a power factor outside the range stipulated in

Table 5, provided this does not cause the *system standards* to be violated.

In some cases, site-specific requirements may necessitate a negotiated requirement, such as significant inverter-based resources to ensure suitable voltage regulation, or connections in weak areas.

Sites that incorporate *loads* and Generating Units operating together shall require a negotiated outcome on the power factor performance.

A Major Customer who installs shunt capacitors to comply with power factor requirements must comply with the DNSP's requirements to ensure that the design does not severely attenuate audio frequency signals used for load control or operations, or adversely impact on harmonic voltage levels at the Connection Point.

#### **4.12.7 Plant energisation**

The energisation of plant for new, or modified, Connections shall comply with the requirements of the Plant Energisation Standard STNW1179. Where a PQ meter is not required according to Section 4.12.8 of this Standard, temporary power quality metering may be required to verify compliance.

#### **4.12.8 Power quality monitoring**

- a. The requirement for a dedicated PQ Class A meter is given as per



Table 6. A power quality meter shall meet the following requirements:

- b. measurement to be based as close as practical to the Connection Point(s); and
- c. installed, owned and managed by the DNSP; and
- d. the Major Customer is to bear the cost of establishing the power quality meter and required enabling plant including CTs and VTs. Compliant CTs and VTs may be owned by the customer and provide the DNSP owned power quality meter the required inputs. The DNSP owned PQ meter shall require a separately fused VT circuit for measurement; and
- e. the VT shall be located on the DNSP network side of the Circuit Breaker if provided by the Major Customer; and
- f. be available to report and verify the power quality compliance at the Connection Point at any time by the DNSP<sup>3</sup>.

---

<sup>3</sup> With reasonable allowance for outages

**Table 6 Power quality meter requirements per Connection category**

Connection category		Power quality meter requirement
Loads <sup>1</sup>	Non Sub-transmission Network Connections	May be required for Connections with significant disturbing <i>loads</i> and/or Connections to weak grids as identified by the Technical Study
	Sub-transmission Network Connections	Shall be required for Connections with significant disturbing <i>loads</i>
EG Systems		Refer to relevant EG Standard

Note 1: authorised demand in the Connection Agreement

## 4.13 Communications and SCADA requirements

The Major Customer shall liaise with the DNSP regarding telecommunication requirements to support SCADA communications, protection communications, and/or other applications as required for the associated secondary systems. Table 7 details SCADA and communications requirement for Major Customers.

**Table 7 SCADA and Communications requirements per Connection category**

Connection category		SCADA and Communications requirement
Loads (authorised demand)	Shared feeder Connections in non Sub-transmission Networks	May be required as identified by Technical Study <sup>1</sup>
	Single Feeder Dedicated Connections in non Sub-transmission Networks	May be required as identified by Technical Study <sup>1</sup>
	Multiple Feeder Dedicated Connections in non Sub-transmission Networks	Shall be required
	Sub-transmission Networks Connections	Shall be required
EG Systems		Refer to relevant EG Standard
Load and Generation hybrid sites		As required by the more onerous categorisation of the <i>load</i> or Generation component

Note 1: The requirement will consider shared Distribution Network topology, GID ownership and visibility, PQ meter availability, protection and control requirements for the Major Customer.

In certain cases, there may be a requirement for control systems to have communications where an automatic *load* curtailment scheme or plant overload Protection Scheme is required.

### 4.13.1 Roles and responsibilities

Due to the requirements for security and interoperability with the DNSP's existing telecommunications networks, the DNSP shall undertake the communications system design, provide equipment specifications and shall therefore determine the configuration of the equipment.

The Major Customer shall be responsible for installing the communications transmission and switching equipment based on this design, as per the installation process and procedures outlined by the relevant DNSP Standards made available at the application process.

The DNSP may, upon request and for an appropriate fee, provide equipment installation and as constructed engineering drawings on behalf of the Major Customer.

Testing can be performed by the Major Customer at the Connection Asset substation as part of an integrated program to test the substation.

Unless otherwise agreed with the DNSP, a Major Customer wishing to achieve inter-networking under the Build, Own, Operate (BOO) model defined in the Manual shall use standard DNSP equipment and configurations, as the introduction of non-standard or alternative equipment will require additional design, integration and testing between the DNSP and the Major Customer.

#### 4.13.2 Communication requirements details

The DNSP has established an ethernet inter-connection capability method as its preferred method which can be considered for use by Major Customers upon application.

Where Internet Protocol (IP) telecommunications between the Major Customer and the DNSP Operational Technology Environment (OTE) is utilised, it shall be done at layer 3 (IP) level which is controlled through an edge defence (ED) device as per Section 4.15.2 of this Standard.

Communications transmission systems are required to meet the DNSP's existing standards and not interfere with DNSP's own Communication signalling. The common transmission systems utilised include optical fibre (Optical Ground Wire (OPGW) and/or All Dielectric Self Supporting (ADSS)), microwave radio systems, and power line carrier.

Where a physical link such as optical fibre is utilised, suitable interfacing near the Connection Point is required such as a joint at a communications pit.

Where duplicated differential schemes are used, there is a requirement for diverse communication paths.

#### 4.13.3 SCADA requirements details

Where SCADA connectivity to the DNSP is required, the Major Customer's SCADA/control systems shall comply with the DNSP's latest standards available during the application process. The RTUs and HMI shall be the same as those used by the DNSP. The Major Customer may design the Customer RTU connections to their plant, but the RTU configuration and programming shall be carried out by the DNSP. The HMI configuration and programming can be performed by the Major Customer but shall be done to relevant DNSP's standards and guidelines.

Appendix E sets out further requirements in relation to communications and SCADA requirements.

## 4.14 Data and information

### 4.14.1 General

This section sets out the general information requirements to enable the DNSP to properly manage its data. Specific power systems information and data required for the Connection planning study is set out in Appendix C.

In addition, where the Major Customer has been offered and elected to undertake a design, construct and transfer of Connection Assets (DCT) model (refer to the Manual for further information on Transferable Connection Assets), the Major Customer must provide the following, as a precondition to the transfer of the relevant assets being affected:

- a. manuals;
- b. specifications;
- c. test reports;
- d. design modules;

- e. standards; and
- f. design drawings, in respect of the relevant assets.

Data includes information on Major Customer assets, planning, environment and cultural heritage.

The project manager nominated by the DNSP is responsible for coordinating the receipt of quality data consistent with this section of the standard.

#### **4.14.2 Determination of method for data delivery**

At the start of a Connection Application, the DNSP and Major Customer shall liaise to determine a satisfactory way to deliver the required data specified in Section 4.14 and Appendix C (including the appropriate formats of such data and timing of delivery) and any other data reasonably required by the DNSP to achieve the critical Connection process milestones prior to commissioning, including (but not limited to) equipment details such as the relevant ratings, test results and nameplate information of the equipment.

#### **4.14.3 Approval of designs**

The Major Customer shall provide a preliminary design approved by an RPEQ, followed by updates as they become available.

All final design drawings for Connection Assets by the Major Customer shall be approved by the Major Customer's RPEQ provided to the DNSP prior to connection.

When the project is commissioned, the "as constructed" drawings must be provided to the DNSP before the transfer of the Transferable Connection Assets to the DNSP can take place.

#### **4.14.4 Data prior to commissioning**

The Major Customer shall, prior to commissioning of the Connection Point, provide all required data to the DNSP.

Neither the energisation of the Connection Point, nor transfer of the Transferable Connection Asset(s), is permitted to proceed until all required data has been provided to the satisfaction of the DNSP.

The Major Customer shall provide all cultural heritage data in respect of the Transferable Connection Assets, where the DNSP will be responsible for the ongoing maintenance or operation of that asset.

#### **4.14.5 Dynamic data and information**

Refer to the relevant Dynamic Connection Standard for generic data requirements associated with a dynamic Connection.

The Technical Study shall further determine the information required for dynamic data and information from the Major Customer installation.

### **4.15 Cybersecurity**

The following section applies to establishing ethernet communications between the DNSP and Major Customer that are not specific to a dedicated protection communications channel. Physical access restrictions may be implemented for DNSP owned Connection Assets in accordance with STNW3039 Network Physical Security – Design Reference.

Protection communication requirements are detailed in Appendix B.

## 4.15.1 Roles and responsibilities

The DNSP may disconnect all IP traffic flows upon suspicion of malicious activities or security breaches.

The DNSP and Major Customer shall keep the other party informed of any planned works and incidents on the telecommunications and Edge Defence equipment that may impact the communications link.

The Major Customer shall inform the DNSP of any cyber security breaches that may impact the operational electrical environment.

The Major Customer shall inform the DNSP of their vulnerability and risk management strategy upon knowledge of a vulnerability advisory affecting the operational electrical environment.

## 4.15.2 Cybersecurity design

The DNSP shall deploy an Edge Defence device that shall be physically installed within the communications room located within the DNSP zone substation, whilst the Major Customer system shall deploy an Edge Defence device that interfaces the DNSP telecommunications network.

The telecommunications link shall be established via IPv4 Layer 3 routable session (eBGP preferred) and shall transit both Edge Defence devices, between the DNSP and Major Customer.

The DNSP and Major Customer shall allow SCADA communications between the DNSP SCADA interface point and the Major Customer SCADA interface point to facilitate the control signalling capabilities.

All IP traffic received from the Major Customer shall undergo continuous deep packet inspection, intrusion detection and protection activities, before the packet is forwarded to the final destination.

The Major Customer shall only be able to send SCADA communications to the single DNSP SCADA interface point within the zone substation.

Internet Control Message Protocol (ICMP) traffic should be allowed between Edge Defence devices to enable troubleshooting capabilities. Table 8 details the security controls related to ethernet traffic.

**Table 8 Security controls related to traffic flows**

Flow ID	Description	Source	Destination	Protocol	Security Controls
1	SCADA traffic	Major Customer SCADA	DNSP SCADA	DNP3	Deep packet inspection Next Generation Firewall
2	SCADA traffic	DNSP SCADA	Major Customer SCADA	DNP3	Deep packet inspection Next Generation Firewall
3	Routing	DNSP Edge Defence device	Major Customer Edge Defence device	eBGP or OSPF or EIGRP or static	Deep packet inspection Next Generation Firewall
4	Troubleshooting	Edge Defence device	Edge Defence device	ICMP	Deep packet inspection Next Generation Firewall
5	Implicit deny all	Any	Any	Any	Non approved flows alerted as possible suspicious activities

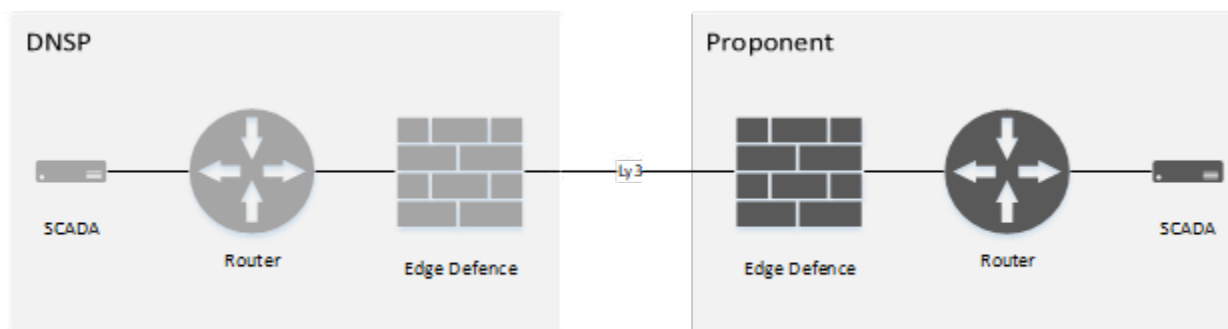

**Figure 1: Information traffic flow architecture representation**

## 4.16 Technical Studies

To connect a Major Customer's Premises, the DNSP shall undertake a technical assessment process, which includes power systems modelling. These studies shall occur at the enquiry stage, as outlined in the Manual.

The Major Customer (both *load* and EG Connections) shall provide the modelling information required as set out in Technical Study and/or Connection Process.

Refer to Appendix C for data requirements.

### 4.16.1 Capacity Studies

As part of the Technical Study, Distribution System capacity impacts of the new or altered Connection shall be assessed to identify required augmentation, if any. This may include the development of curtailment schemes.

### 4.16.2 Fault Current Contribution

Fault current contribution shall be calculated, if applicable, to determine if equipment ratings are exceeded for the relevant proposed network configurations.

### 4.16.3 Voltage Management

Voltage management impact and required changes as a result of the new or altered Connection shall be assessed. It shall be determined whether augmentation or operational changes are required, to ensure the voltage regulation of the Distribution Network remains within required limits based on the proposed Major Customer's installation.

Major Customer Premises that have Embedded Generation, significant inverter-based *loads* and/or reactive plant shall comply with a voltage rise limit of a maximum value of 0.5% at the Connection Point over the existing voltage levels (as determined by the DNSP) prior to Connection anywhere in the HV Distribution Network, due to the power export of the Generating System, or the impact of the Major Customer's reactive plant or *load* (e.g. capacitor banks, significant cabling). As a mitigation, systems may need to operate in voltage control mode, with settings as determined as part of the Technical Study.

### 4.16.4 Performance Standards

For Major Customers connecting under Chapter 5A of the NER, the required performance standards shall be defined as part of the Technical Studies. For Major Customers connecting under rule 5.3A or rule 5.3, the performance standards under S5.2 of the NER shall be negotiated as defined in S5.3.4 of the NER.

Further information regarding the respective Connection processes can be found in the Manual.

## 4.16.5 Power quality allocation

Flicker and harmonic allocations shall be conducted as part of the Technical Study.

## 4.16.6 Rejection studies

Load and/or Generation rejection studies shall be conducted during the Connection process. The voltage change on any part of the Distribution System upon rejection shall be limited to:

- a. In case of overvoltage and undervoltage, +/- 5%, for system normal Distribution Network configuration for all Major Customer Connections and for N-1 network configurations in;
  - i. Class A2 and Class B EG Systems in Distribution Networks; and
  - ii. Connections to Sub-transmission networks.

After considering the Technical Study, the DNSP may allow a larger excursion provided there would be no adverse impact on other *distribution network users*,

The overvoltage performance shall not exceed the limits prescribed in Figure S5.1a.1 in the NER.

## 4.16.7 Dynamic Modelling requirements

Modelling requirements for EG Systems shall apply as per the relevant Standards such as in STNW1174, STNW1175 or STNW3511.

Loads greater than 1.5 MVA comprising of fast acting control systems, including plant such as STATCOMs, static var compensators, static frequency converters or power electronic converters may be required to provide appropriate dynamic modelling at the application stage. This will be determined and defined during the Technical Study.

## 4.16.8 Protection requirements

Protection requirements shall be identified as part of the Technical Study.

## 4.17 Interlocking

Fail-safe interlocking mechanisms shall be required as specified in Table 9 for Premises with multiple transformers or multiple Connection Points, bumpless transfer and off-grid Connections. HV Connections may not need to be interlocked and are subject to a review in the Technical Study. LV Connections shall require fail-safe interlocking.

**Table 9 Interlocking requirements**

Connection arrangement	Fail-safe interlocking <sup>1</sup> requirements
Multiple transformers or multiple Connection Points	Major Customer's transformers cannot be connected in Parallel either at HV or LV where multiple Distribution System supplies exist.
Bumpless transfer	During the transfer from one source to another, the interlock operation cannot enable the EG Unit and the Distribution System to both supply the <i>load</i> at the same time longer than the maximum allowable duration for bumpless transfer in the relevant EG Standard as applicable. No distribution transformers will be connected in Parallel at any point during the bumpless transfer.
Off grid	During the transfer from one source to another the interlock operation cannot allow the Generating Unit and the Distribution System to both supply the <i>load</i> at the same time.

Note 1: The interlocking mechanism should be a mechanical fail-safe system. Electronically controlled interlocking systems may be allowed upon approval of a functional design and operational specification certified by an RPEQ in the application stage.

## 4.18 Load Shedding Schemes

For Major Customers with expected peak demands in excess of 10 MVA, load shedding procedures shall be applied by AEMO in accordance with the provisions of Schedule S5.3.10 of the NER for the shedding of all *loads* including sensitive *loads*.



## 5 Testing and commissioning

Testing and commissioning shall verify that the Major Customer's Premises:

- a. do not adversely affect the security of the Distribution System or the quality of supply of electricity through the Distribution System;
- b. comply with the agreed performance requirements referred to in the relevant Connection Agreement; and
- c. do not pose a risk of causing damage to the Distribution System, or any equipment of any other *distribution network user* that is connected to the Distribution System.

Testing and commissioning requirements shall consider the following:

- i. testing and commissioning plans shall be prepared by the Major Customer and may be required to be approved by the DNSP under the Connection Agreement;
- ii. the commissioning plan and acceptance shall be carried out by an RPEQ;
- iii. testing and commissioning acceptance may require the DNSP to carry out witnessing at the Major Customer's expense;
- iv. testing shall involve installation test, not type tests; and
- v. any other requirements as set out in the Energy and Safety Laws and Regulations.

## 6 Operations and maintenance

### 6.1 General

Where applicable, such as defined in the DNSP EG Standards, or where HV-connected Major Customers own isolating devices or protection equipment; operations and maintenance requirements apply. This includes, but is not limited to:

- a. an operation and maintenance manual for the relevant plant shall be produced by the Major Customer, and a copy accessible on site;
- b. the Premises shall be operated and maintained to ensure compliance at all times with the Connection Agreement and all applicable legislation, codes, and/or other regulatory instruments;
- c. operation and maintenance reports may be required by the DNSP at a specified interval no more frequently than annually;
- d. the electrical installation at the supply address shall be maintained in a safe and accessible condition;
- e. subject to paragraph 6.1f below, the Major Customer shall ensure that any changes to the electrical installation at the supply address are performed by a licensed electrical worker lawfully permitted to do the work, complying with the design by an RPEQ and that the Major Customer holds a Certificate of Compliance issued in respect of any of the changes;
- f. the Major Customer shall seek DNSP approval prior to altering the electrical Connection in terms of an addition, upgrade, extension, expansion, augmentation or any other kind of alteration that is involved in the primary and secondary *plant*; and
- g. the Major Customer shall notify the Distributor of any scheduled and unscheduled protection or communications outages or failures.

The DNSP may at its own cost inspect the Major Customer's LV or HV installation at any time in accordance with the terms of the relevant Connection Agreement or as otherwise permitted under the Energy and Safety Laws. The DNSP may require access to the site of the Major Customer's system and isolation points for Distribution System maintenance and testing purposes.

If the DNSP determines through an audit or an investigation that the Connection is non-compliant with the requirements set out in the Connection Agreement, the DNSP shall advise the Major Customer of this in writing. If the concern has a material impact on the Distribution System, the DNSP shall disconnect the Major Customer until the non-compliance has been remediated by the Major Customer to the DNSP's satisfaction in accordance with the DNSP's rights under the Connection Agreement, Energy Laws or other legislative instrument.

## 6.2 HV Connections

As a requirement of Queensland Electrical Safety legislation, Major Customers who have a high voltage electrical installation shall prepare an Installation Safety Management Plan for their workplace. The plan shall address the risks associated with the operation and maintenance of the high voltage installation.

This may include:

- a. a single line diagram for the installation, showing all switches and circuit breakers and their identifying labels or numbers;
- b. site-specific operating rules covering all aspects of operating the high voltage installation, including procedures for arranging isolation of the installation from the local electricity network;
- c. procedures for identifying hazardous areas including any confined spaces associated with the installation;
- d. competency requirements for persons who may be permitted to operate or work on the high voltage installation, including appropriate requirements for re-training, re-testing and re-accreditation;
- e. induction procedures for new contractors;
- f. regular inspection and maintenance programs to ensure the installation remains serviceable and safe;
- g. procedures for ensuring there is no extension or alteration of the installation without permission from the local electricity entity if the works necessitates an alteration to the Connection Agreement;
- h. procedures for the safe handling of insulating oils and other substances that may be required for maintenance or repair; and
- i. procedures including warning signs for ensuring that all parts of the high voltage installation (e.g. underground cables and high voltage overhead power lines) are not damaged by heavy vehicles or other mobile plant, for example mobile cranes.

The Major Customer shall engage the services of a Queensland Electrical Safety Office Accredited Auditor to provide a certificate inspection and confirmation for the installation including the Installation Safety Management Plan and, operation and maintenance manual.

## 6.3 Operating protocol

All HV connected Major Customers and some LV connected Major Customers (e.g. CBD high rise buildings) will be required to have an operating protocol in place between the DNSP and the Major Customer. The operating protocol will provide the basis for mutually agreed and uniform operating procedures relating to the Connection Point. Operational practices may evolve over time, and the Operating Protocol shall be updated and amended from time to time to reflect the applicable arrangements.

The Operating Protocol will be developed collaboratively by the nominated persons from the DNSP and the Major Customer and will detail:

- a. up-to-date site contact name(s) and details;
- b. site access and physical security;
- c. the process for managing planned outages, outage coordination, repairs and maintenance;
- d. the process for managing unplanned outages, repairs and maintenance;
- e. communications protocols;
- f. maintenance policy;
- g. auxiliary services;
- h. site operational information as relevant;
- i. information regarding protection across the Connection Point; and
- j. switching procedures.

Each party shall retain a copy and advise the other in case of required updates.

# Standard for Major Customer Connections

## Appendix A – Major Connection Arrangement Options (normative)

### Overview

In the following options, the design and construction of Connection Assets is provided by the DNSP as an Alternative Control Service.

The arrangements in Appendix A are to be interpreted as generic standards and site-specific reviews shall determine the final outcome and requirements. The DNSP reserves the right to nominate the most appropriate Connection option for any particular Connection Application and the Major Customer shall not make any assumptions on any option presented in Appendix A and proceed to design without the explicit approval from the DNSP.

**Table 10 Connection Arrangement Option summary**

Connecting voltage	Reference	Description	Connection Point	Network Coupling Point	Premises capacity <sup>1</sup>
LV	L.1	Standard LV - OH	Customer side of the switch fuse	OH	1 MVA – 1.5 MVA
LV	L.2	Standard LV - UG	Customer side of the switch fuse	UG	1 MVA – 1.5 MVA
LV	L.3	OH LV dual transformer supply	Customer side of the switch fuse(s)	OH	>1 to 3 MVA
LV	L.4	OH LV dual transformer supply(separate HV feeders)	Customer side of the switch fuse(s)	OH	>1 to 3 MVA
LV	L.5	UG LV dual transformer supply	Customer side of the switch fuse(s)	UG	>1 to 3 MVA
LV	L.6	LV Connection-chamber sub	Customer side of the LV CB	UG	>1 to 4.5 MVA
LV	L.7	LV Mesh	Customer side of the LV CB	UG	>1 to 4.5 MVA
11-33 kV	H.1	Simple OH	Customer side of the HV CB	OH	Subject to site-specific topology.
11-33 kV	H.2	Simple UG	Customer side of the HV RMU	UG	
11-33 kV	H.3	Dedicated Feeder	Customer side of the ACR for OH, Distribution System side of Customer CB for UG	OH/UG	
11-33 kV	H.4	Dual HV	Customer side of the ACRs for OH, Distribution System side of Customer CBs for UG	OH/UG	
11 kV	H.5	HV Mesh	Customer side of the HV CB	UG	
> 33 kV	S.1	Tee Connection	Customer side of line isolator	OH	
> 33 kV	S.2	Dedicated Feeder	Customer side of line isolator	OH/UG	
> 33 kV	S.3	Switching station	Network side of line isolator	OH	
> 33 kV	S.4	Three bay Tee	Network side of line isolator	OH/UG	
> 33 kV	S.5	Dual feeder high reliable alternate supply with switching substation	Customer side of line isolator	OH	
> 33 kV	S.6	Dual feeder supply with switching substation	Customer side of line isolator	OH	

Note 1: The LV Connection capacities are based on standardised distribution transformer and switchgear capacities that may change from time to time.

## NMI Allocation

NMIs shall be allocated according to the [National Metering Identifier Procedure](http://www.aemo.com.au) available on the AEMO website ([www.aemo.com.au](http://www.aemo.com.au)).

## Low Voltage Connections

### L.1 Standard LV Connections - overhead

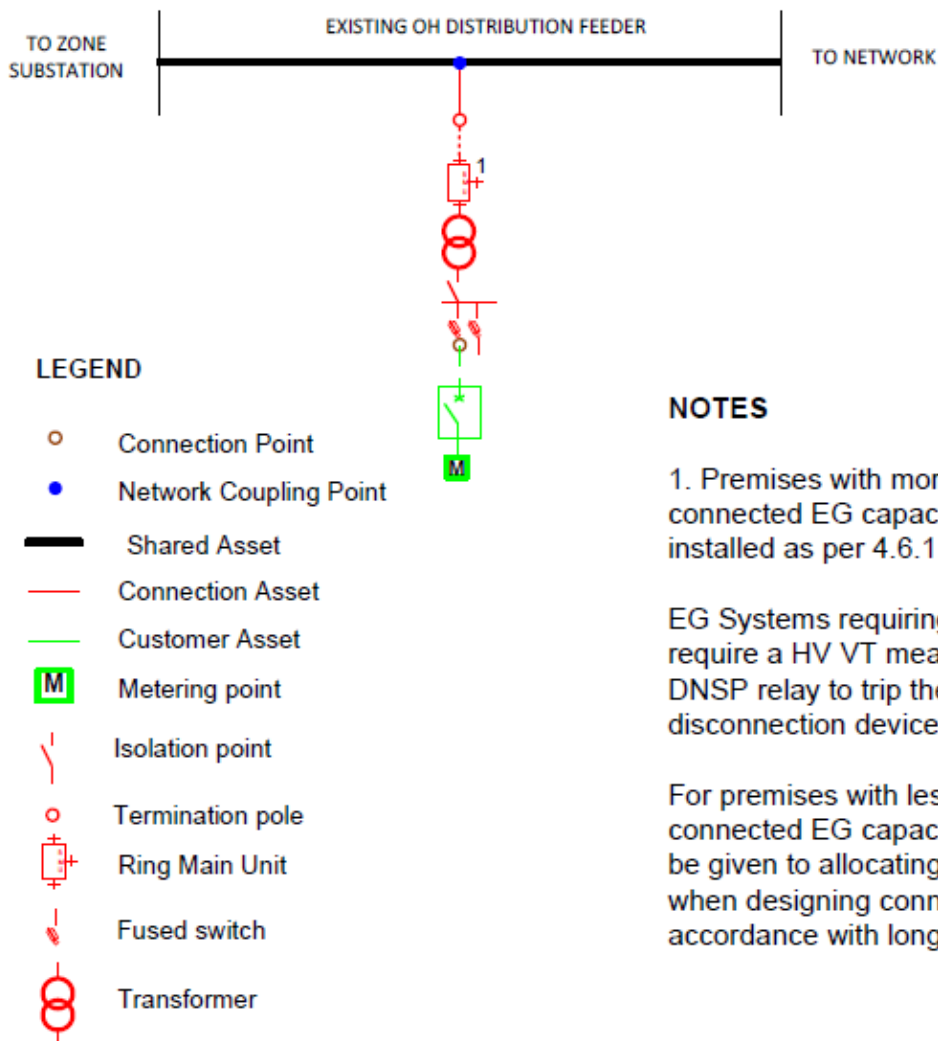

## L.2 Standard LV Connections - underground

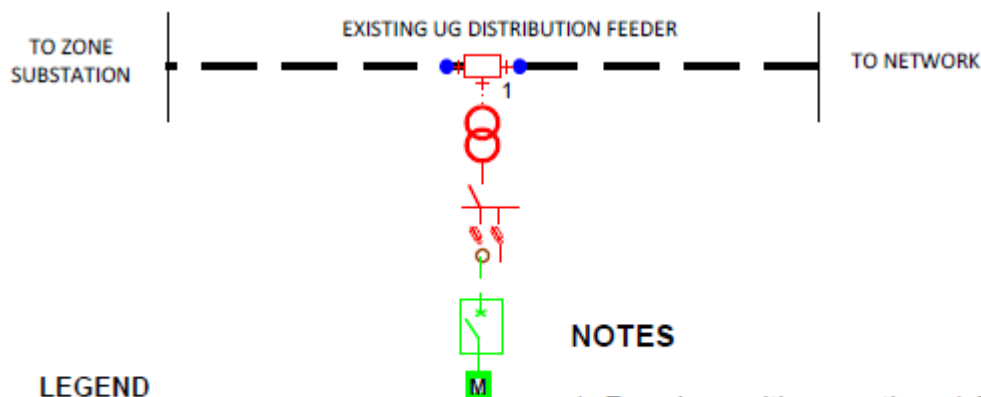

### LEGEND

- Connection Point
- Network Coupling Point
- Shared Asset
- Connection Asset
- Customer Asset
- Metering Point
- Isolation point
- Ring Main Unit
- Fused switch
- Transformer

### NOTES

1. Premises with more than 1.5 MVA of connected EG capacity shall have a GDD installed as per 4.6.1.







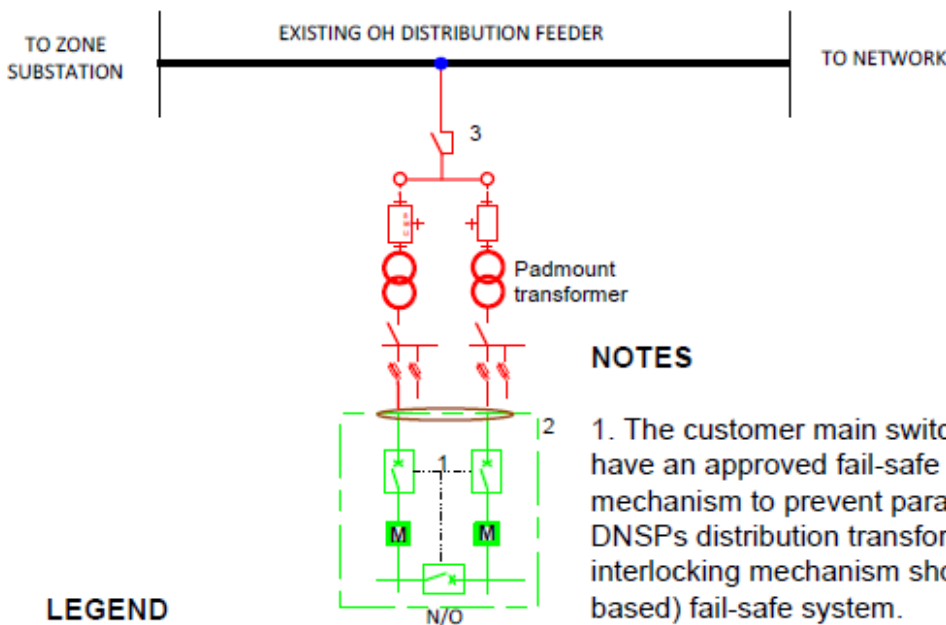



EG Systems requiring NVD protection shall require a HV VT measurement used by a DNSP relay to trip the Customer disconnection device.

For premises with less than 1.5 MVA of connected EG capacity, consideration should be given to allocating space for a future GDD when designing connection assets in accordance with long-term site needs.

## L.3 Overhead LV Connection with dual transformer supply



### LEGEND

-  Connection Point
-  Network Coupling Point
-  Shared Asset
-  Connection Asset
-  Customer Asset
-  Metering Point
-  Recloser with bypass
-  Termination pole
-  Ring Main Unit
-  Isolation point
-  Fused switch

### NOTES

1. The customer main switchboard (MSB) shall have an approved fail-safe interlocking mechanism to prevent parallel connection of the DNSP's distribution transformers. The interlocking mechanism should be a manual (key based) fail-safe system.

2. A single connection point / single NMI is only possible where all transformers are located in the same building in the same switchroom supplying into one Major Customer LV switchboard and where supply originates from same Distribution feeder.

3. Premises with more than 1.5 MVA of connected EG capacity shall have a GDD installed as per 4.6.1.

EG Systems requiring NVD protection shall require a HV VT measurement used by a DNSP relay to trip the Customer disconnection device.

For premises with less than 1.5 MVA of connected EG capacity, consideration should be given to allocating space for a future GDD when designing connection assets in accordance with long-term site needs.







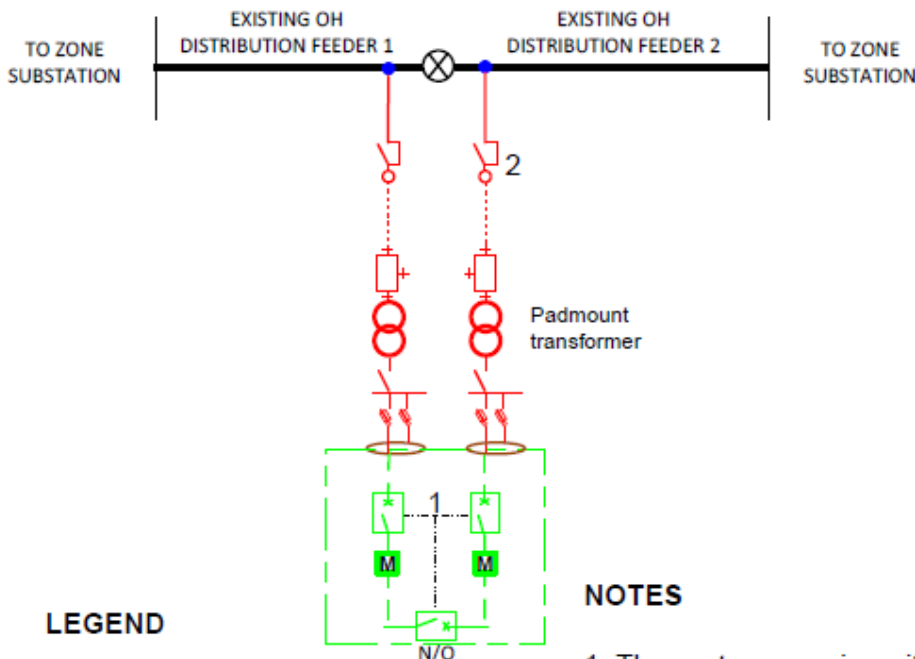





A maximum of two transformers shall be allowed for a premise.

# Standard for Major Customer Connections

## L.4 LV Connection with dual transformer supply (separate HV overhead feeders)



### LEGEND

-  Connection Point
-  Network Coupling Point
-  Shared Asset
-  Connection Asset
-  Customer Asset
-  Metering Point
-  Recloser with bypass
-  Ring Main Unit
-  Termination pole
-  Isolation point
-  Fused switch
-  Normally open switch

### NOTES

1. The customer main switchboard (MSB) shall have an approved fail-safe interlocking mechanism as per Section 4.17 to prevent parallel connection of the DNSP's distribution transformers.

2. Premises with more than 1.5MVA of connected EG capacity shall have a GDD installed as per 4.6.1.

EG Systems requiring NVD protection shall require a HV VT measurement used by a DNSP relay to trip the Customer disconnection device.

For premises with less than 1.5MVA of connected EG capacity, consideration should be given to allocating space for a future GDD when designing connection assets in accordance with long-term site needs.







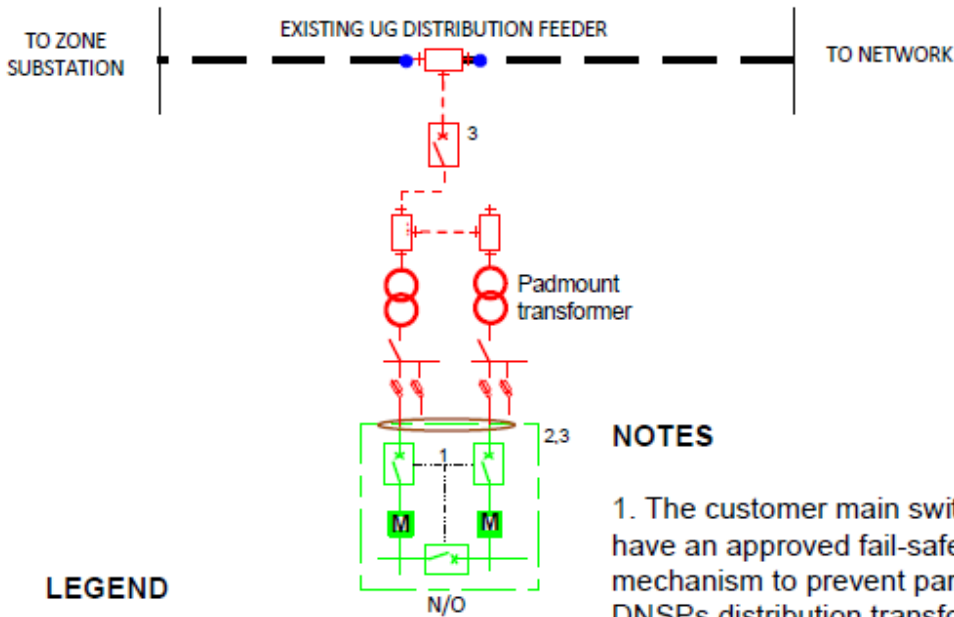



A maximum of two transformers shall be allowed for a premise.



## L.5 Underground LV Connection with dual transformer supply



### LEGEND

-  Connection Point
-  Network Coupling Point
-  Shared Asset
-  Connection Asset
-  Customer Asset
-  Metering Point
-  Ground-mounted Recloser
-  Ring Main Unit
-  Isolation point
-  Fused switch

### NOTES

1. The customer main switchboard (MSB) shall have an approved fail-safe interlocking mechanism to prevent parallel connection of the DNSPs distribution transformers. The interlocking mechanism should be a manual (key based) fail-safe system.

2. A single connection point / single NMI is only possible where all transformers are located in the same switchroom.

3. Premises with more than 1.5 MVA of connected EG capacity shall have a GDD installed as per 4.6.1.

EG Systems requiring NVD protection shall require a HV VT measurement used by a DNSP relay to trip the Customer disconnection device.

For premises with less than 1.5 MVA of connected EG capacity, consideration should be given to allocating space for a future GDD when designing connection assets in accordance with long-term site needs.

A maximum of two transformers shall be allowed for a single premise.

A variation for load only Major Customers is shown below. Connection arrangements requiring GDD as per Section 4.6.1 shall have the option above.

# Standard for Major Customer Connections



Part of Energy Queensland

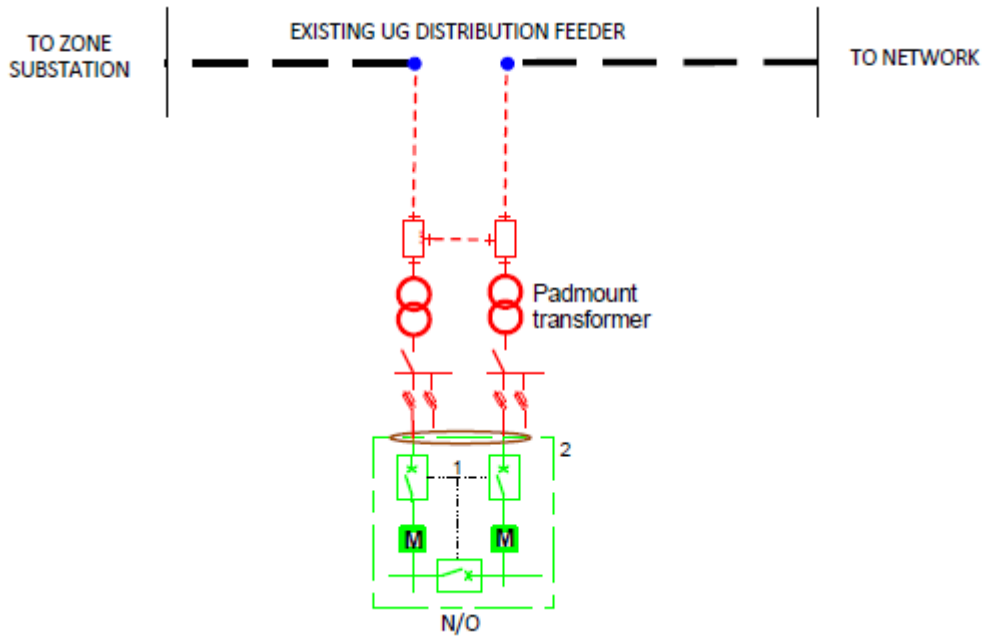

## L.6 LV Connection via chamber substation

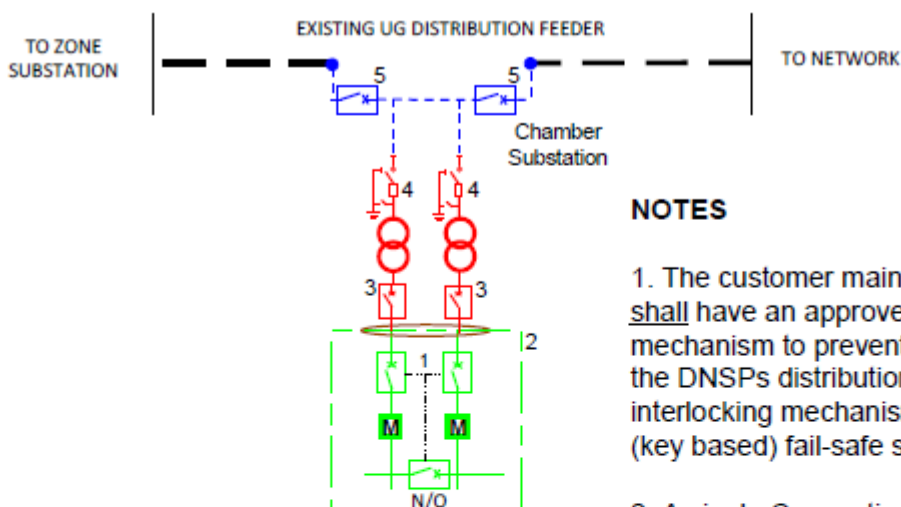

### NOTES

1. The customer main switchboard (MSB) shall have an approved fail-safe interlocking mechanism to prevent parallel connection of the DNSPs distribution transformers. The interlocking mechanism should be a manual (key based) fail-safe system.

2. A single Connection Point / single NMI is only possible where all transformers are located in the same switchroom supplying one Customer LV Switchboard.

3. A DNSP owned LV switchboard may be built to facilitate CMEN and streetlight circuits.

4. Fused switch may be replaced by a circuit breaker/protection relay for future GDD option.

5. These incoming breakers may not be required where the Major Customer is not connecting to a part of a meshed (i.e., network source can come from either direction) Distribution Network, pending protection assessment.









Premises with more than 1.5MVA of connected EG capacity shall have a GDD installed as per 4.6.1.

EG Systems requiring NVD protection shall require a HV VT measurement used by a DNSP relay to trip the Customer disconnection device.

For premises with less than 1.5 MVA of connected EG capacity, consideration should be given to allocating space for a future GDD when designing connection assets in accordance with long-term site needs.

A maximum of three transformers shall be allowed for a single premise.

### LEGEND

-  Connection Point
-  Network Coupling Point
-  Shared Asset
-  Connection Asset
-  Customer Asset
-  Metering Point
-  Fused switch
-  Circuit breaker
-  Transformer

## L.7 LV mesh Connection

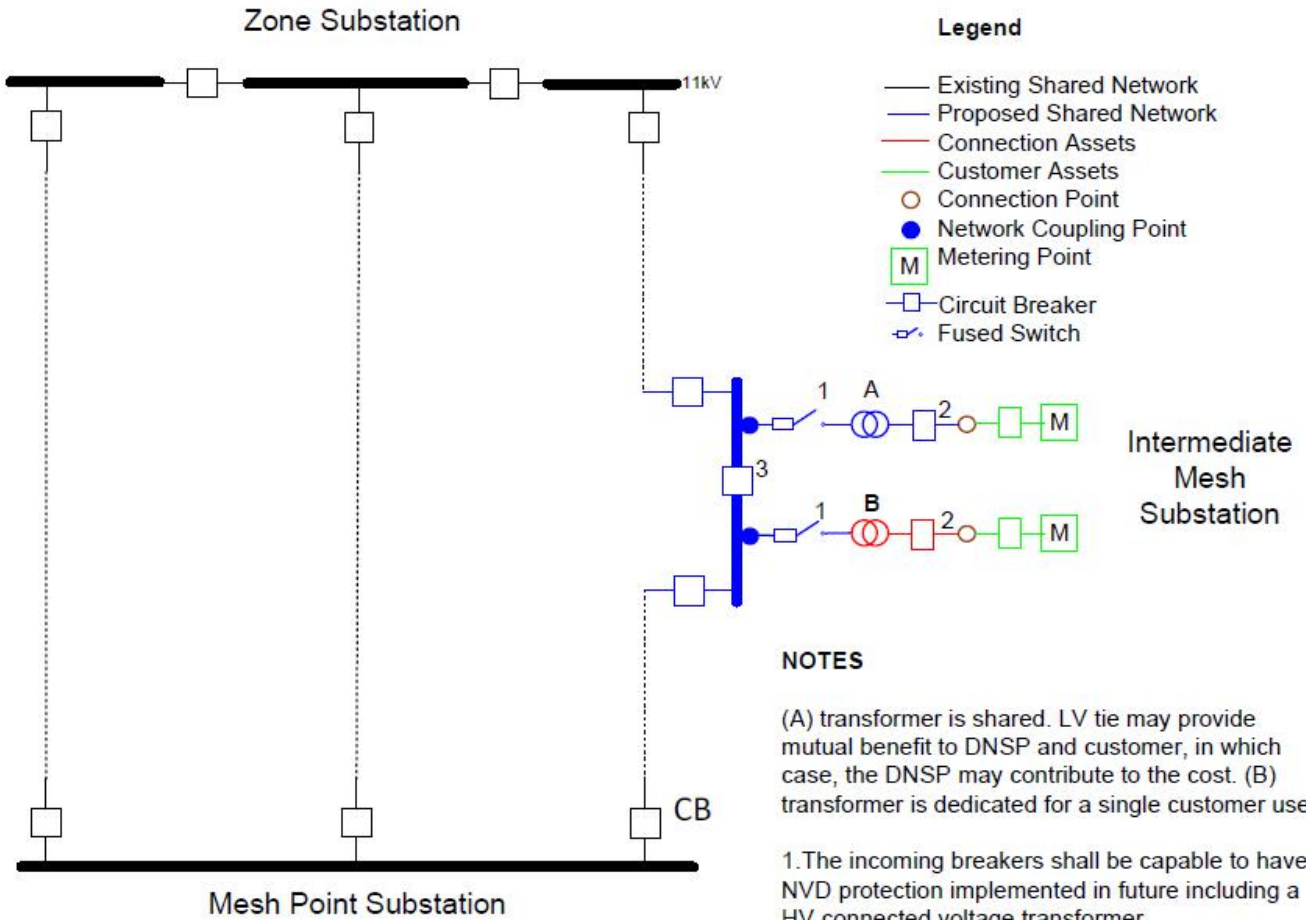

### NOTES

(A) transformer is shared. LV tie may provide mutual benefit to DNSP and customer, in which case, the DNSP may contribute to the cost. (B) transformer is dedicated for a single customer use.

1. The incoming breakers shall be capable to have NVD protection implemented in future including a HV connected voltage transformer.

2. The LV connections shall be as per LV U/G Chamber substation option. If this arrangement was purely for one customer as a result of the Connection Application, the Network Coupling Points will be deemed to be at the HV Distribution Network prior to Network extension similar to L.6 (Chamber sub option) .

3. Switch in feeder between NCP may not be used. It may be funded by DNSP identified in Network Development Plan.





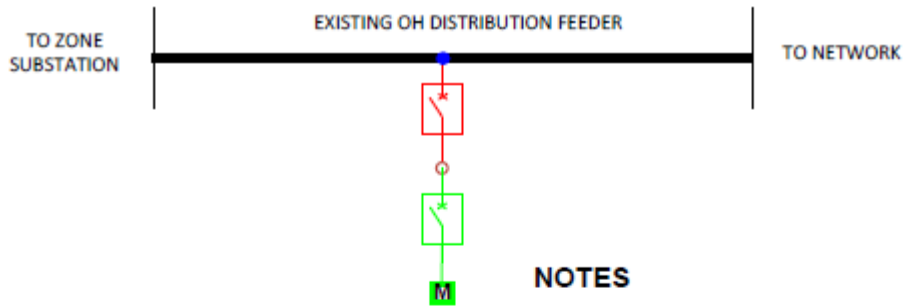

The development may have single or multiple end-use customers (and NMLs) after construction.

## High Voltage Connections

### H.1 11 / 22 kV / 33kV (Distribution) simple overhead Connection



#### LEGEND

-  Connection Point
-  Network Coupling Point
-  Shared Asset
-  Connection Asset
-  Customer Asset
-  Metering Point
-  Recloser or circuit breaker

#### NOTES

1. A DNSP owned GDD (recloser) will be required at the connection point unless the Major Customer can demonstrate that their protection system design is compliant with the requirements outlined in Section 4.10.







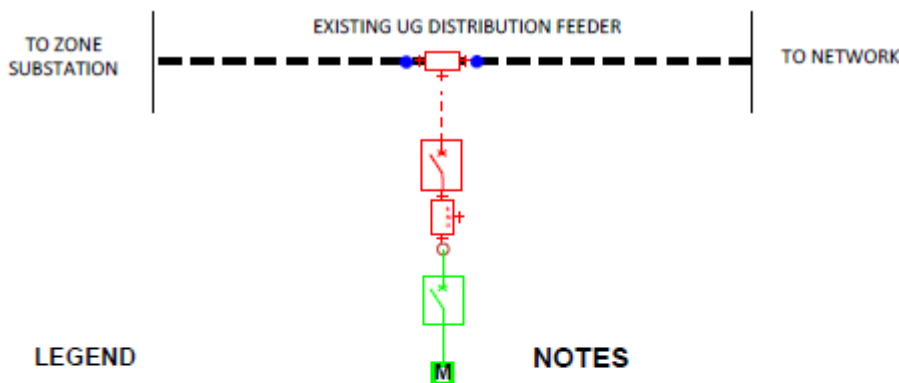

Installations with more than 1.5 MVA EG capacity shall have a DNSP owned GDD installed to be compliant to Section 4.6.1.

If a second circuit is requested for additional supply, then the construction of the secondary circuit will be treated as Alternative Control Services.

## H.2 11 / 22 kV / 33kV (Distribution) Simple underground Connection



### LEGEND

-  Connection Point
-  Network Coupling Point
-  Shared Asset
-  Connection Asset
-  Customer Asset
-  Metering Point
-  Recloser or circuit breaker
-  Ring Main Unit

### NOTES

Connection Assets shown are Dedicated Connection Assets.

A DNSP owned protection device will be required at the connection point unless the Major Customer can demonstrate that their protection system design is compliant with the requirements outlined in Section 4.10.

A downstream recloser may be required for EG connections if identified through Technical Study.

Installations with more than 1.5 MVA EG capacity shall have a DNSP owned GDD installed to be compliant to Section 4.6.1.

Consideration should be given to allocating space for a future GDD when designing connection assets in accordance with long-term site needs.

If a second circuit is requested for additional supply, then the construction of the secondary circuit will be treated as Alternative Control Services.

## H.3 11 / 22 kV / 33 kV (Distribution) dedicated Connection

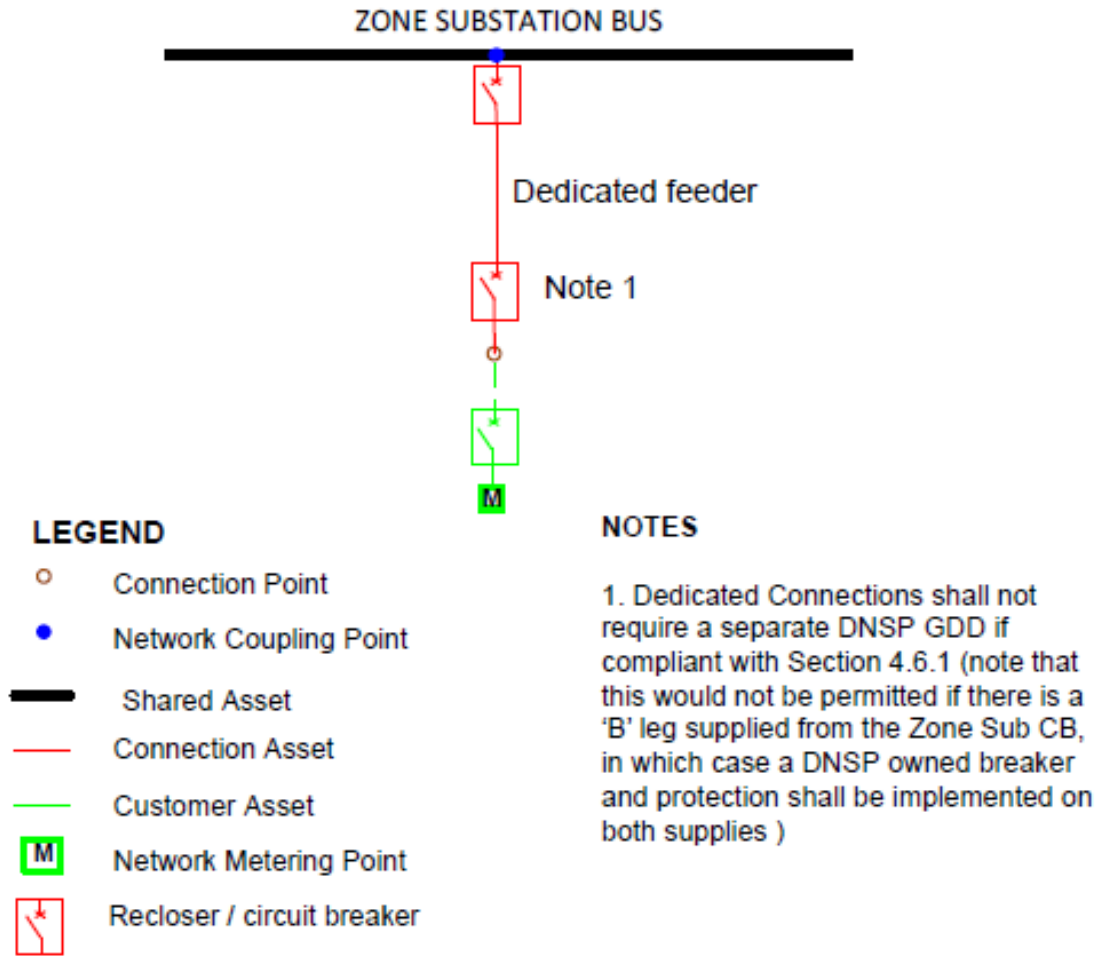

# Standard for Major Customer Connections

## H.4 11 / 22 kV / 33 kV (Distribution)– dual supply

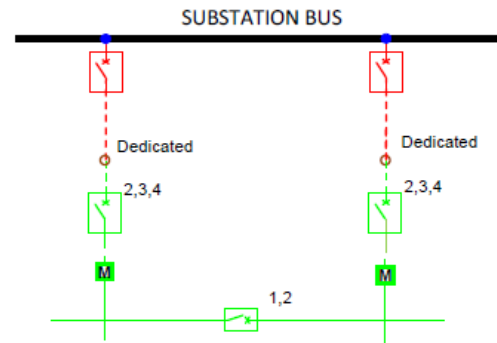
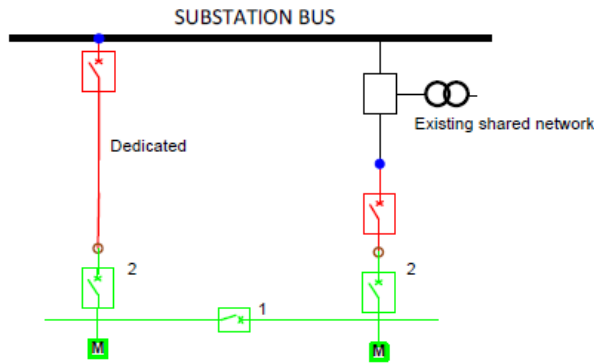

### LEGEND

- Connection Point
- Network Coupling Point
- Shared Asset
- Connection Asset
- Customer Asset
- M** Metering Point
-  Recloser or circuit breaker

### NOTES

1. To be operated Normally Open and interlocking may be required to avoid paralleling of the upstream network.
2. DNSP shall have visibility of these CB's.

### NOTES

1. To be operated Normally Open and may require interlocking to avoid paralleling of the upstream network.
2. DNSP shall have visibility of these CB's.
3. Customer incoming CB's shall be capable to have NVD protection implemented.
4. DNSP owned separate protection relay shall be made to operate the customer incoming circuit breakers for designs requiring a GDD.



# Standard for Major Customer Connections

## H.5 11kV – mesh connection

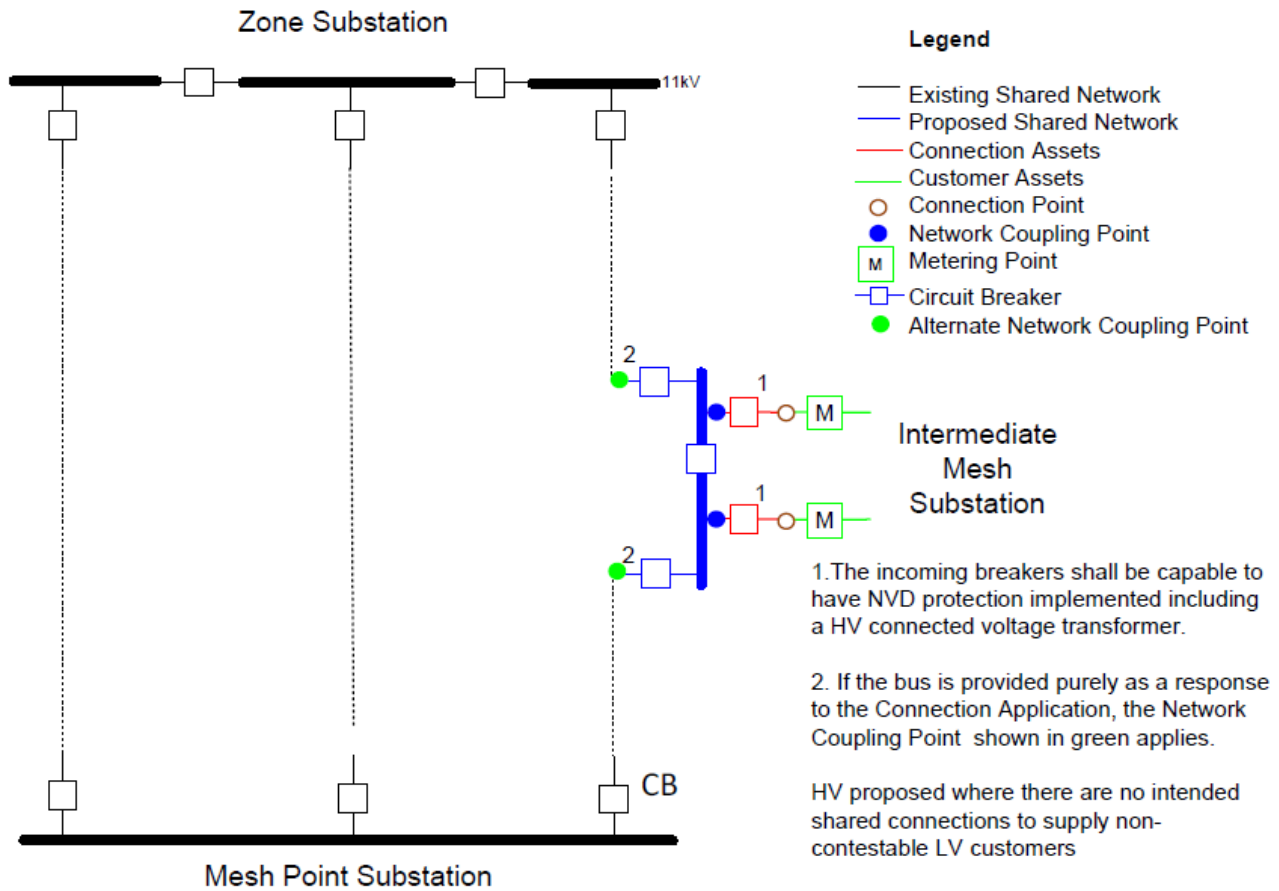



## Sub-Transmission Network Connections

The decision as to whether the expansion of existing DNSP substation facilities or the establishment of an additional new substation shall be based on alignment with DNSP operational and network planning requirements and demonstrated cost effectiveness over the lifecycle of the installation. As such, not all connection topologies will be available for every connection. This will be further advised during the enquiry stage.

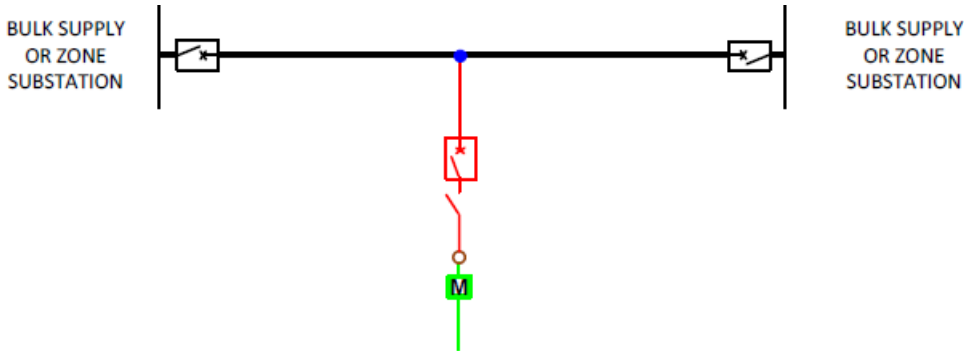
### S.1 Sub-Transmission - “T” Connection



#### LEGEND

- Connection Point
- Network Coupling Point
- Shared Asset
- Connection Asset
- Customer Asset
- M** Network Metering Point
-  Circuit breaker
-  Isolator

#### NOTES

The DNSP shall own the T-substation primary and secondary plant for all Major Customer types.

Addition of generation may increase protection and communications requirements.

Installations with more than 1.5 MVA EG capacity shall have a GDD installed as per 4.6.1. Consideration should be given to GDD space provision for long term site needs.

## S.2 Sub-transmission - dedicated Connection

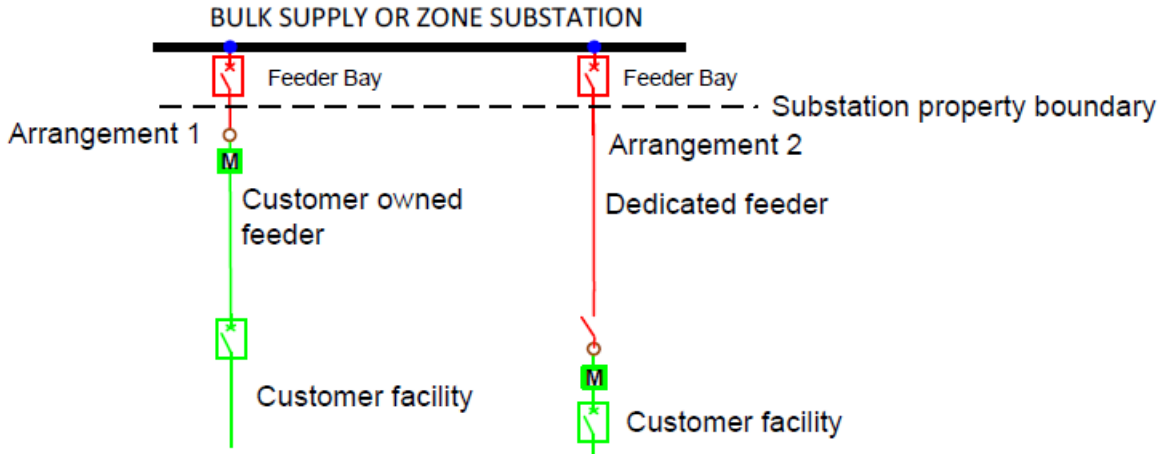

### LEGEND

- Connection Point
- Network Coupling Point
- Shared Asset
- Connection Asset
- Customer Asset
- M Metering Point
- Circuit breaker
- ⏏ Isolator

### NOTES







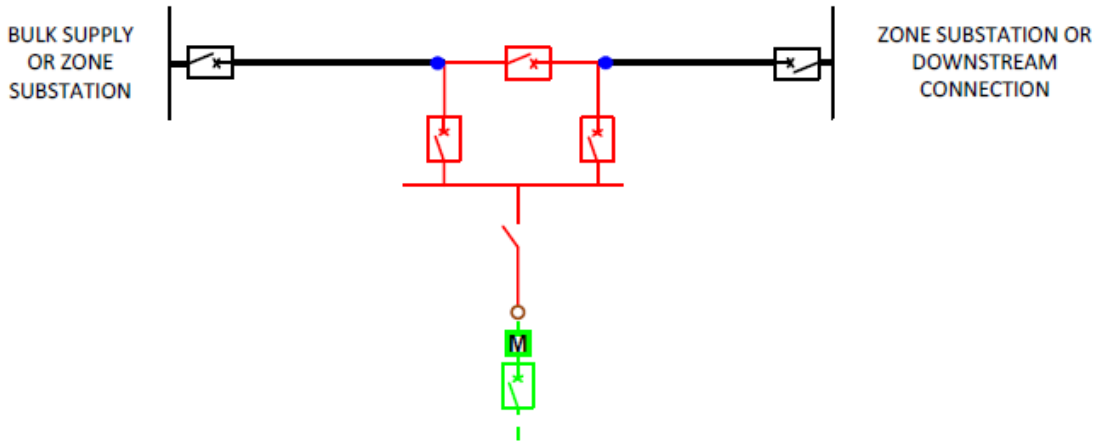

Arrangement 1 shows a Major Customer owned feeder. Protection scheme elements at customers end can be either Major Customer or DNSP owned.

Arrangement 2 shows an DNSP owned feeder. Secondary protection scheme elements (protection relays and associated communications equipment) at Major Customers end shall be owned by the DNSP. Other elements of the Protection Scheme (circuit breakers, CT, VT, DC supplies, etc.) can be either Major Customer or DNSP.

## S.3 Sub-Transmission Connection via switching station



### LEGEND

-  Connection Point
-  Network Coupling Point
-  Shared Asset
-  Customer Asset
-  Connection Asset
-  Circuit breaker
-  Metering Point
-  Isolator







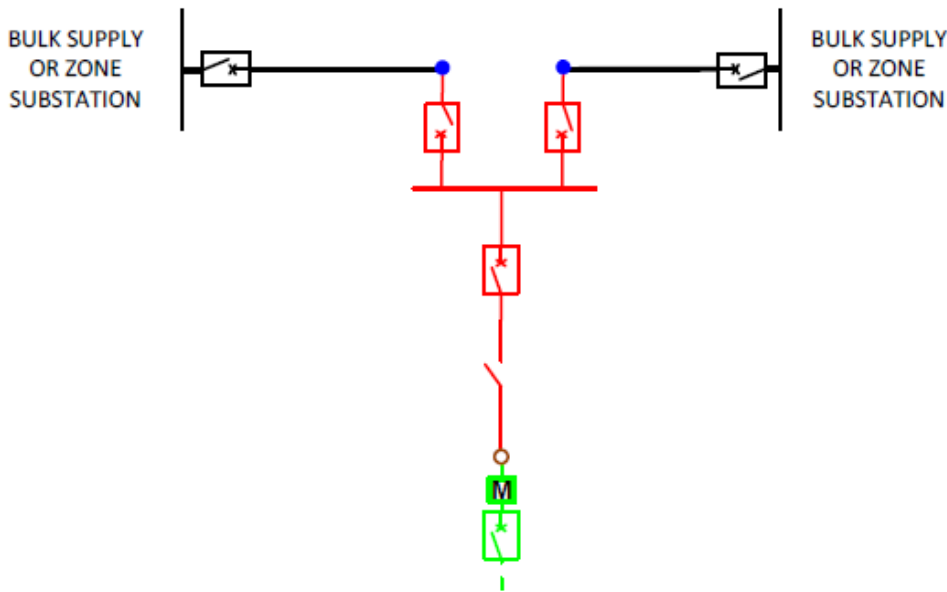

### NOTES

The DNSP shall own the switching substation. This arrangement is used to cut into radial lines where power flows are uni-directional. This arrangement would be required based on the Major Customers need for high reliability (compared to T-substation or 3 bay tee), etc.

## S.4 Sub-Transmission Connection – three bay tee



### LEGEND

-  Connection Point
-  Network Coupling Point
-  Shared Asset
-  Customer Asset
-  Connection Asset
-  Circuit breaker
-  Metering Point
-  Isolator

### NOTES

The DNSP shall own the switching substation. This arrangement shall only be used on a ring network where all supply scenarios can be maintained from either existing DNSP substation. This arrangement would be required based on the Major Customers need for high reliability (compared to T-substation), etc.

## S.5 Sub-Transmission Connection via dual feeders – Option 1

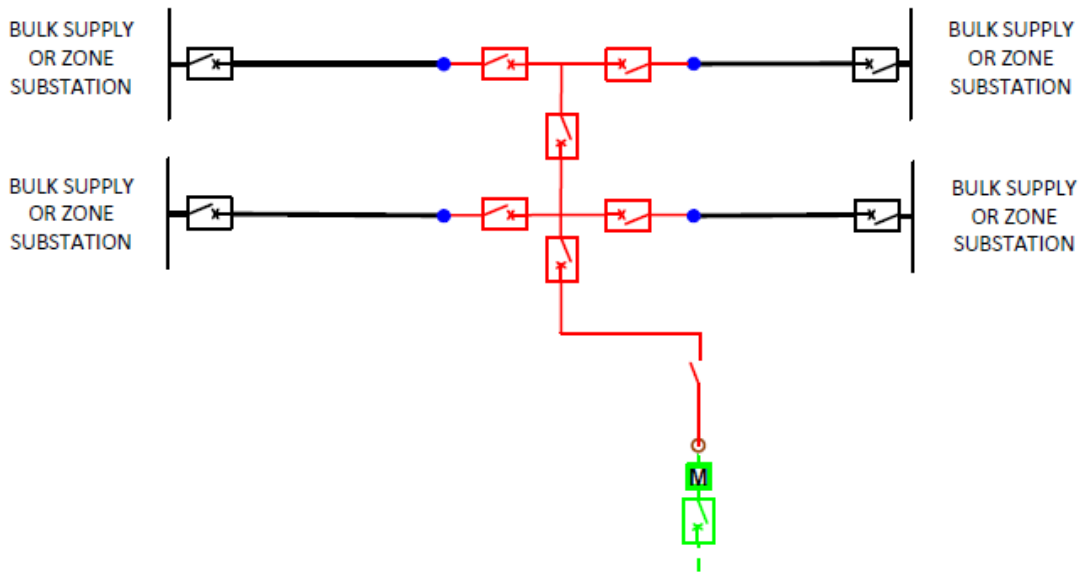

### LEGEND

- Connection Point
- Network Coupling Point
- Shared Asset
- Customer Asset
- Connection Asset
- Circuit breaker
- M Metering Point
- ⌋ Isolator

### NOTES

The DNSP shall own the switching substation. This arrangement would be required based on the Major Customers need for high capacity or reliability (compared to a dual T).

## S.6 Sub-Transmission Connection via dual feeders – Option 2

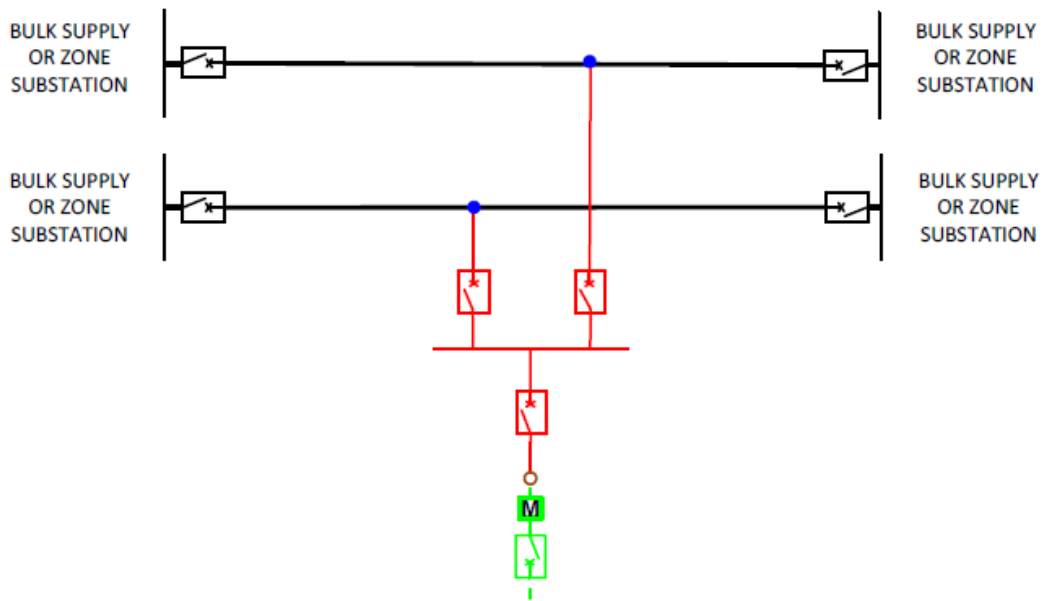

### LEGEND

- Connection Point
- Network Coupling Point
- Shared Asset
- Customer Asset
- Connection Asset
- Circuit breaker
- M Metering Point
- ⋈ Isolator

### NOTES

The DNSP shall own the switching substation. This arrangement would be required based on the Major Customers need for high capacity.

## Appendix B: Protection and communications design requirements (normative)

### B.1 General

A number of standard options have been developed to streamline the Major Customer Connection process, facilitate compliance with expected requirements and maintain Distribution Network reliability at compliant levels.

Connections with EG Units shall refer to the relevant DNSP's EG standards for requirements.

The preferred Protection Schemes to be implemented in the Major Customer Connection arrangements are set out below.

### Protection Scheme Arrangements

Protection Scheme arrangements will be determined by (but not limited to);

- nature of Connection - *load* and/or Generation,
- line voltage,
- proximity of the new connection with respect to the existing DNSP substation, and
- proximity of the customer to the new substation.

Clearing times are defined by Table S5.1a.2 in the NER. Redundancy requirements are defined by Clause S5.1.9(d) of the NER.

### B.2 Distribution

Note: these diagrams are simplified to articulate Protection Scheme arrangements only.

#### Option 1: Over Current Feeder Management

This involves a dedicated feeder bay emanating from a zone substation for a radial *load* of 4 MVA and above for voltages 22/11 kV and involves:

- at the DNSP end, a feeder management relay or relays depending upon the level of available back-up protection to meet NER requirements. Relay/s as per DNSP's current relay period contract.



PS – Over Current feeder management for a radial load of 4MVA and above (for voltages 22/11kV).

Additional protection requirements may apply according to the relevant DNSP's relevant EG Standard if EG Units are present at the Connection Point.

#### Option 2: Line Differential & Feeder Management

This involves a dedicated feeder bay emanating from a zone substation for all Generation applications of 4 MVA and above for voltages 22/11 kV and involves:



# Standard for Major Customer Connections

- at the DNSP end, a line differential Protection Scheme and a feeder management relay, relays as per current relay period contract with a compatible line differential relay at the remote Major Customer end; and
- protection communications suitable for line differential protection communications is required.

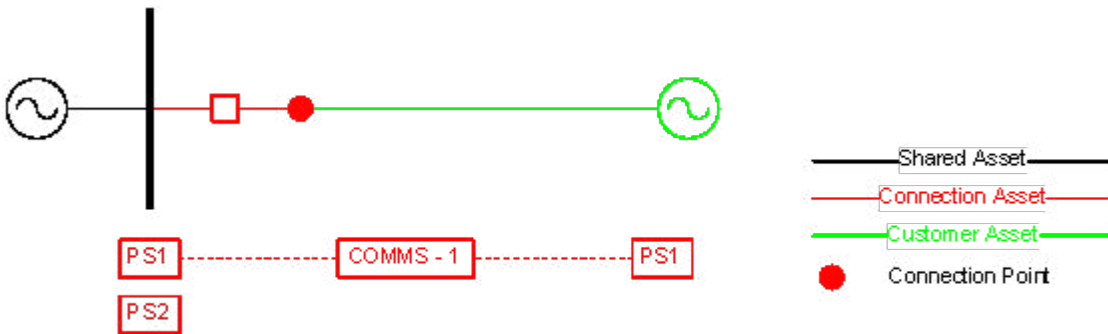

PS1 –Line differential protection & comms  
 PS2 –Over current feeder management relays  
 (Generation applications of 4MVA and above for voltages 11/22kV).

## B.3 Transmission / Sub-transmission

### Option 3: Distance protection – No communications

This involves a dedicated feeder bay emanating from a zone substation with only radial *load* and a line length greater than ~10 km for voltages 132/110/66/33 kV, and involves:

- at the DNSP end, two distance Protection Schemes, with relays as per current relay period contract;
- protection communications are not mandatory for this option, unless required to meet NER clearing times. Additionally, other customer communication requirements may need to be provided.

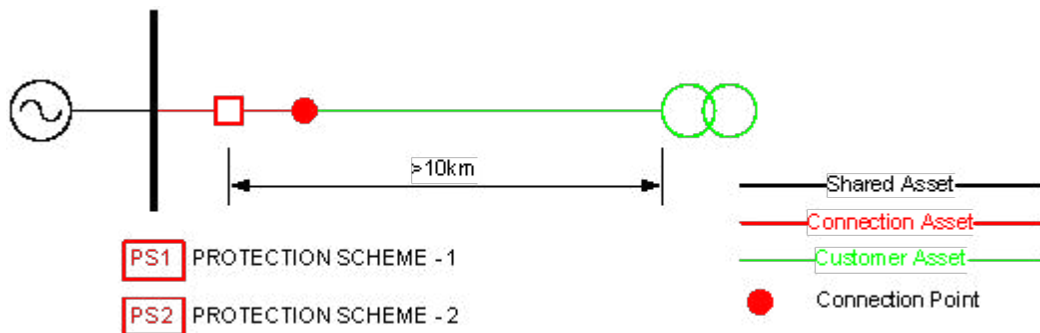

PS1 & PS2 –Distance – No Comms (Line length >10km, for voltages 220/132/66/33kV).

### Option 4: Line differential protection + communications

This involves a dedicated feeder bay emanating from a zone substation with only radial *load* and line length less than 10 km for voltages 132/110/66/33kV and involves:

- at the DNSP end, two line differential Protection Schemes, relays as per current relay period contract, with compatible relays at the remote Major Customer end; and
- protection communications shall be suitable for line differential protection communications, duplicated and diverse paths shall be provided for 220/132/110 kV applications in order to

meet NER clearing times. 66/33 kV applications may have an alternative scheme negotiated.

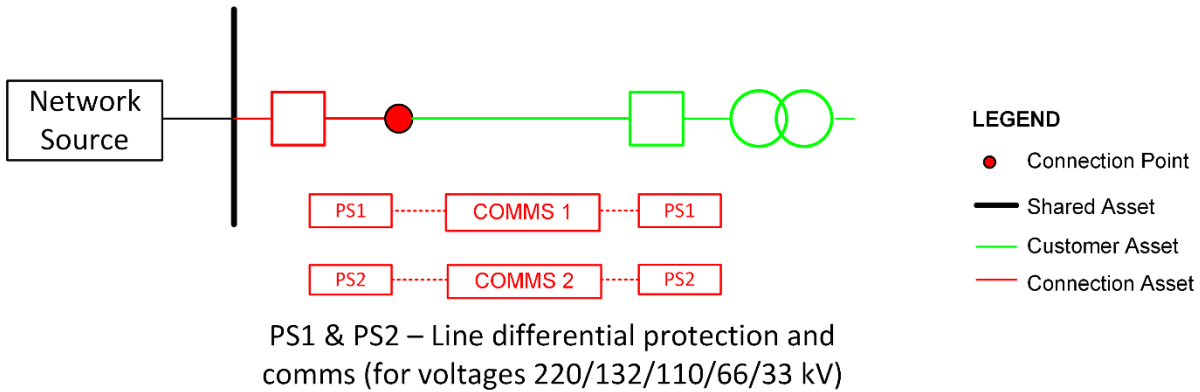

## Option 5: Line Differential Protection + Communications

This involves a dedicated feeder bay emanating from a zone substation for all Generation applications for voltages 220/132/110/66/33 kV and involves:

- at the DNSP end, two line differential Protection Schemes, relays as per current relay period contract, with compatible relays at the remote Major Customer end; and
- protection communications shall be suitable for line differential protection communications, and duplicated and diverse paths shall be provided.

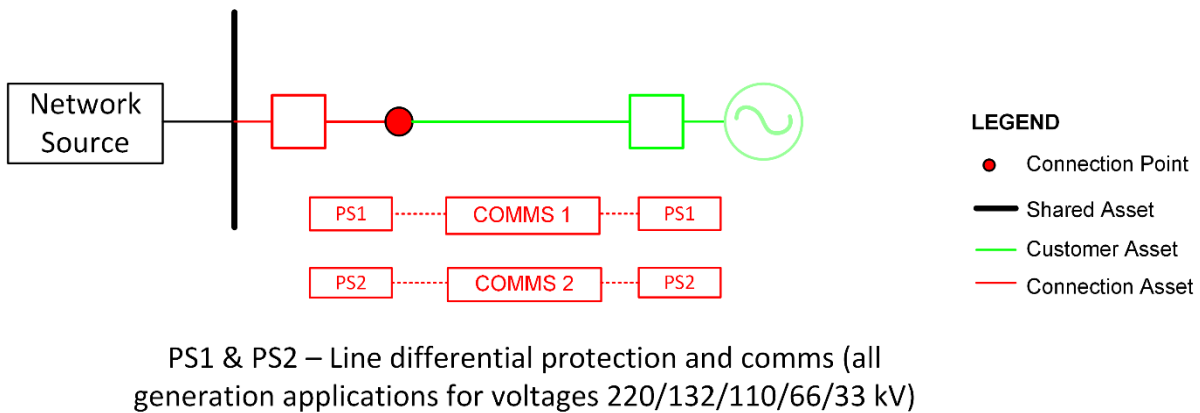

## B.4 Switching stations

### Option 6: Intermediate switching station – radial feeder

If an intermediate switching station is to be established on a radial feeder to facilitate a Major Customer Connection, the interconnector to the switching station is to be developed in line with Option 7 and the associated sketch, and the dedicated bay to the Connection Point (and the new feeder if created by the sectioning) shall be considered against Options 1-5 above. If the existing protection is not capable of providing the required functionality, a remote upstream protection upgrade shall be required in these instances to facilitate the Major Customer Connection.

## Option 7: Intermediate switching station

If an intermediate switching station is to be established between two existing zone substations to facilitate a Major Customer Connection, then each inter-connector to the switching station shall require either duplicated line differential or line differential and distance protection in permissive over-reach mode (POR) and the further dedicated bay to the Connection Point shall be considered against Options 1-5 above.

Protection communications suitable for the combination of line differential and/or POR (permissive over-reach) schemes shall be required. If the existing protection is not capable of providing the required functionality, remote upstream protection upgrade shall be required in these instances to facilitate the Major Customer Connection.



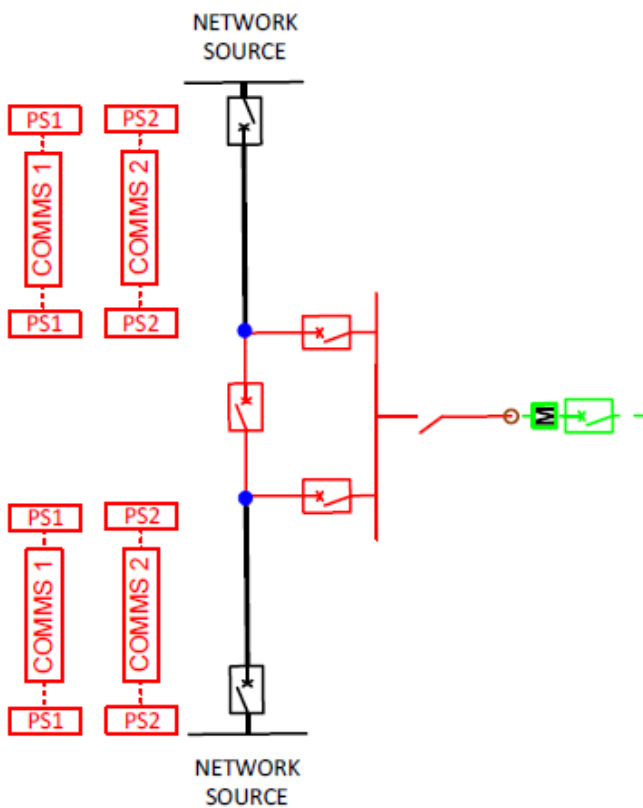





The Major Customer is required to fund the costs of establishing new communications links and additional or replacement protection relays.



### NOTES

PS1 and PS2 – Duplicated line differential protection or line differential and distance in permissive overreach mode (POR). Protection on customer feeder as per Options 1-4.

### LEGEND

-  Connection Point
-  Network Coupling Point
-  Shared Asset
-  Customer Asset
-  Connection Asset
-  Circuit breaker
-  Metering Point
-  Isolator

## Appendix C: Data and Information (informative)

Data and information shall be provided by the Major Customer to the DNSP based on the application type and may include some of the following below (but not limited to):

The Major Customer shall provide the DNSP with technical details of:

- a. the impedances of the Premises Network including cables, lines, transformers, etc.
- b. secondary equipment such as control equipment, voltage regulators, STATCOMs and power factor correction equipment;
- c. plant that can contribute to the fault current in the Distribution Network such as chillers, motors and generators; and
- d. EG system static data and information requirements, as referred to in the relevant EG Standard.

### C.1 Format for designs

All designs submitted to the DNSP shall be in an electronic format suitable both for direct printing of drawings and in a CAD format suitable for transfer to GIS and drawing management systems. The files provided shall include:

- i. Adobe PDF format with a paper size to suit CAD files title block; and
- ii. Line designs where required shall be in CAD format readable and to data specification using the DNSP's External Design Tool (AutoCAD) that will allow electronic loading directly into the DNSP's GIS, without further requirement for manual intervention; and
- iii. Substation designs shall be in CAD format readable by DNSP preferred Design Tool or AutoCAD and be compliant with DNSP's design specifications.

### C.2 Use of AutoCAD and relevant numbering requirements

The Major Customer shall provide a single line diagram and design information to the DNSP's relevant design group through the DNSP's Major Customer Sponsor at the earliest opportunity.

The Major Customer shall obtain the relevant numbering requirements from the DNSP's relevant design group.

The Major Customer shall deliver all line designs compatible with the DNSP's external design tool (AutoCAD).

## Appendix D: Works classification and construction options (normative)

### D.1 Construction and ownership options

There are broadly three “default” options which can be used for the construction and ownership of Connection Assets required for a Major Customer Connection connecting to the Distribution Network. These options are clarified in Table 11 below.

**Table 11 Construction and Ownership Options for Connection Assets**

Option	Acronym	Explanation
Option 1 Major Customer designs, constructs, owns and operates their Connection Assets.	BOO	This involves the Major Customer carrying out the design, construction and ongoing operation and maintenance of the Connection Assets at its expense. These works are to be carried out according to the relevant Australian Standards, industry codes and statutory requirements. Any ACS works being done by the DNSP (in respect of the DNSP’s assets) will be recovered up-front from the Major Customer, and the cost of any SCS will be recovered by the DNSP under relevant NOCCs. Note some restrictions exist around the design of secondary systems such as communications, SCADA, protection and metering.
Option 2 Major Customer designs and constructs the Connection Assets and then transfers these to the DNSP.	DCT	This involves the Major Customer carrying out the design and construction of some or all of their Connection Assets at its expense, and upon acceptable completion, transferring some or all of those assets (namely, the Transferable Connection Assets) to the DNSP. Upon transfer, the DNSP will be responsible for the ongoing maintenance and operation of the Transferable Connection Assets (any non-transferred assets remain the responsibility of the Major Customer). Any Transferable Connection Assets must comply with the DNSP’s standards and guidelines, as well as all planning, environmental and cultural heritage laws and approvals, and be constructed using approved equipment and contractors (where specified). Auditing obligations will be imposed on the Major Customer under the NCEC. Additionally, the DNSP will inspect and audit works to ensure that they are designed, constructed and installed to comply with the DNSP’s standards and guidelines. The use of approved equipment and contractors assists in maintaining common spare parts and standardising product training for the DNSP employees so that costs and the duration of outages caused by any failure of such Transferable Connection Assets can be minimised. Again, any ACS works being done by the DNSP will be recovered up-front from the Major Customer, and the cost of any SCS will be recovered by the DNSP under relevant NOCCs.
Option 3 The DNSP designs, constructs, owns and operates the Connection Assets.	DNSP BOO	This involves the DNSP carrying out the design and construction for the dedicated Connection Assets as an ACS, including obtaining all required environmental and planning approvals. The DNSP will be responsible for the ongoing maintenance and operation of these assets. The AER-approved formula is used by the DNSP to determine the cost to the Major Customer. The cost of any SCS will be recovered by the DNSP under relevant Connection Agreement for Ongoing Services.

## Testing and commissioning for the BOO option

The Major Customer shall, prior to commissioning of any of its Connection Assets, give the DNSP a copy of an HV audit certificate for relevant HV assets that is supplied by an appropriately accredited and authorised auditor.

The Connection Applicant/Service Provider shall ensure that all electrical and mechanical tests are performed in accordance with the appropriate regulations and standards. Pre-commissioning tests on certain equipment may be required. These tests will be listed in the testing program.

The DNSP will need to be satisfied that all HV equipment, control and protection equipment, auxiliary supplies and earthing requirements are in compliance with specific manufacturer’s requirements and/or its own internal operational and maintenance requirements. This will be done through the appropriate party carrying out relevant tests, and where the appropriate party is not the DNSP, the DNSP will usually need to witness the relevant tests.

In addition, the DNSP will not energise the Connection Point or connect any HV equipment until it is satisfied that the Major Customer has met certain requirements set out in the NOCC (such as provision of required Securities etc.).

## D.2 Works classification and construction options

**Table 12 Works Classification and construction Options**

Asset Category	Works to supply Connection Applicant	Classification	DCT available Energex	DCT available Ergon Energy
Bulk Supply or Zone Substation	New assets or augmentation of existing assets e.g. switchgear, transformers that is not dedicated	SCS	No	No
	New assets or augmentation of existing assets e.g. switchgear, transformers that is dedicated	ACS	No	No
Dedicated Substation assets located outside DNSP property/ substation or switchyard 33kV and over.	New assets, e.g. feeder bay, transformer bay	ACS	No	Yes, subject to risk assessment

# Standard for Major Customer Connections



Part of Energy Queensland

Asset Category	Works to supply Connection Applicant	Classification	DCT available Ergonex	DCT available Ergon Energy
HV Feeders or sections of HV feeder (11kV to 132kV)	New feeder or augmentation of existing feeder where feeder is expected to supply customers other than the Connection Applicant identified in the planning horizon forward plan. Examples: HV feeder will form part of the Network supplying other customers. Overhead construction with multiple circuits where at least one circuit is supplying other customers. Underground construction with multiple conduits or circuits where at least one circuit supplying other customers.	SCS	No	No
	Removal of a constraint to supply an embedded generator	ACS	No	No
	Augmentation of the Distribution Network to facilitate greater reliability than defined by the Distribution Authority	ACS	No	No
	New feeder or section of feeder is dedicated to connecting the Connection Applicants only – Excludes augmentation and relocation and not identified in the planning horizon forward plan	ACS	Yes	Yes
Distribution Substations on Connection Applicant's Premises or Development Site <sup>4</sup> (LV, 11kV, 22kV or 33kV)	Transformers and LV switchgear supplying Connection Applicant's facilities at the site only.	ACS	Yes	Yes
	HV cables and HV switchgear at the site where Connection arrangement involves: A single "loop in / loop out" HV cable Connection to the Distribution Network, and No protection relay controlled HV network switchgear is involved.	ACS	Yes	Yes

<sup>4</sup> A development site may comprise one or more Registered Property Lots.

# Standard for Major Customer Connections



Part of Energy Queensland

Asset Category	Works to supply Connection Applicant	Classification	DCT available Energen	DCT available Ergon Energy
	HV Cables and HV switchgear at the site where Connection arrangement involves more than a single "loop in / loop out" Connection to the Distribution Network.	SCS	No	No
	Protection relay controlled HV network switchgear.	SCS	No	No
Dedicated secondary systems	Communication/ protection assets that are solely used by the Major Customer.	ACS	Yes	Yes
Shared Secondary systems	Shared communication and or protection asset.	SCS	No	No
Customer's Assets	Downstream of the Connection Point.	N/A.	At Major Customer's discretion.	At Major Customer's discretion.
Metering	Dedicated to Major Customer, usually located adjacent to Connection Point.	Unregulated e.g. metering	Retailer or Major Customer to appoint Metering Provider	Retailer or Major Customer to appoint Metering Provider

## Temporary Supplies

Temporary Supplies are considered Major Customer Connections and their removal at project closure may be subject to an ACS fee if undertaken by the DNSP.



## Appendix E: Scada and Communications Requirements (informative)

Information set out below is generic only and intended to be indicative only. Actual arrangements and requirements may vary due to the connection type, advancement in technology, or cyber security requirements.

### E.1 Time stamp data and sequence of events

DNSP requires sequence of event data from customer plant, where the plant is a power system element such as circuit breakers, EG Units and protection trips. This data shall be time stamped at the first collection device.

Where customer data does not fall into this category, it may be acceptable to transmit any data required by DNSP over protocols that do not support timestamping.

### E.2 DNSP control systems hardware

DNSP is currently standardised on DNP3 SCADA protocol. The current SCADA Outstations support:

**Slave:** DNP3 Level 2 (Request & Response)

**Master:** DNP3 Level 1 (Requests) and Level 2 (Response)

Further details are provided below in E.6.

### E.3 Minimum customer SCADA Requirement

The Major Customer SCADA shall have a minimum requirement of supporting:

**Slave:** DNP3 Level 1

With the following additions: SOE Timestamping

### E.4 Other SCADA protocols

Other SCADA protocols may be considered on request by the Major Customer. The request should take into account any requirements due to time stamping.

### E.5 Communications Link

Multiple data links may be required for operational purposes as per Table 12.

**Table 13 Date links**

Master	Slave	Type	Comment
DNSP	Customer	Serial/ Ethernet	Transmit Ramp Down commands Receive Generation unit status and analogues
Customer	DNSP	Ethernet	Optional: customer receives DNSP status and analogues

Where serial communication is utilised, configuration as per Table 14 applies.

**Table 14 Serial Configuration**

Setting	Configuration	Comment
Type	Serial	
Baud	9600/ 19200	Higher speed on request
Data Bits	8	
Parity	N	
Stop Bits	1	
Flow Control	Off	

## E.6 SCADA Protocol & Configuration

DNSP currently uses DNP3 as standard Outstation to Master station protocol. The tables below detail suggested scan rates, configuration and functions DNSP supports as standard. The DNSP standard addressing has been provided below in Table 15. Please advise customer Master and Slave DNP addressing.

Time synchronisation for the connected customer device is required. This may be provided by the Major Customer's own clock (e.g. GPS) or may be provided from the DNSP RTU (Stratum-3) through DNP3 time sync commands, synchronised from the DNSP GPS clocks.

**Table 15 Example DNP3 Unit Addressing**

Link	Master	DNP3 Address	Slave	DNP3 Address
1	Ergon	0	Customer	1

The following Table 16 defines timing and buffer size for DNP3 object class scans. Where a report by exception is utilised, the buffers may be set smaller (default: 1) to send data immediately upon change. Retries and timeouts parameters as per Table 17 apply.

**Table 16 Scan Rates & buffers**

Class Scan	Binary Indications	Analog Indications	Time (s)	Buffer Size
0	Integrity poll with flags	Integrity poll with flags	3600	-
1	Event poll with flags and Time	-	2	1000
2	-	Event poll with flags and time	3	60000
3	Unused	Unused	-	-

**Table 17 Retries, Timeouts**

Type	Retries/Timeouts (ms)
App Layer Retries	0
App Layer Timeouts	7000
Link Layer Retries	0
Link Layer Timeouts	2000
Confirmation Timeouts	8000
Response Timeouts	9000
In Scan Timeouts	0

**Table 18 DNP3 Functions/Internal Indications**

Type	Versions	Supported/Comment
Secure Authentication	V2, V5	Not Supported
SOE Time Stamping	-	Yes Enabled by default, Millisecond SOE Timestamp
Time Synchronisation	-	Yes, DNSP RTU synced from DNSP OCC Clock. Customer PLC time sync from DNSP RTU available.
Unsolicited/ Report by Exception	-	Yes (Function code 20, 21)

## E.7 DNP3 Object types

DNSP accepts DNP3 data types in the following formats as per Table 19. All data points shall be configured to report both Static and Event data.

**Table 19 DNP3 Object Configuration**

Type (example)	Description	Object	Variation	Notes	Class	Minimum
Digital	1-bit Binary Input Static	1	1	Single bit packed	0	✓
Digital	1-bit Binary Input Event	2	2	Input w/time	1	✓
Analog	32-bit Analog Input w/flag	30	1		0	
Analog	16-bit Analog Input w/flag	30	2		0	✓
Analog	16-bit Analog Input change event w/time	32	4		2	✓
Control Operation	Control Relay Output Block Preferred Configuration: <ul style="list-style-type: none"> <li>SELECT/OPERATE</li> <li>Trip/Close pair</li> <li>Pulse On, 500ms</li> </ul>	12	1		-	✓
Setpoint Operation	16-bit Analog Output Block Preferred Configuration: <ul style="list-style-type: none"> <li>DIRECT OPERATE</li> </ul>	41	2		-	✓
Class 0	Class Objects – Class 0 data	60	1			✓
Class 1	Class Objects – Class 1 data	60	2			✓
Class 2	Class Objects – Class 2 data	60	3			✓
Class 3	Class Objects – Class 3 data	60	4			✓

Circuit Breakers shall be configured as two single bit digital input points as per the following Table 20.

**Table 20 2-bit digital status configuration**

Bits	State
00	Indeterminate
10	Open
01	Closed
11	Invalid

## E.8 Analog resolution

The following table indicates default resolution and delta bandwidth for analogue indications.

**Table 21 Resolutions and Delta bandwidth**

Data Type	Units	Resolution	Constant Poll $\Delta$ Bandwidth
Apparent Power	MVA	0.01	0.1
Real Power	MW	0.01	0.1
Reactive Power	Mvar	0.01	0.1
Current	A	0.1	1
Voltage	kV	0.01	0.1



Part of Energy Queensland

[ergon.com.au](http://ergon.com.au)  
[energex.com.au](http://energex.com.au)

PO Box 1090, Townsville QLD 4810  
GPO Box 1461, Brisbane QLD 4001

Ergon Energy Network  
ABN 50 087 646 062

Energex is the trading name of  
Energex Limited  
ABN 40 078 849 055